



**OMNEX**  
TRUSTED WIRELESS™

# Wood-Mizer North America

## Installation / Configuration Manual

### T300 Transmitter R160 Receiver

March 27, 2008

DM-R160-0427A

Revision 2

#74-1833 Coast Meridian Road, Port Coquitlam, BC, Canada • V3C 6G5

Ph# (604) 944-9247 • Fax# (604) 944-9267

Toll Free 1-800-663-8806

# Table of Contents

System Overview .....	3
Features .....	3
T300 Dimensions and Controls .....	3
Installing the Receiver .....	4
Receiver Dimensions .....	4
Special Functions .....	5
Installation Considerations.....	6
Power the Transmitter .....	6
Test the Transmitter / Receiver Link.....	7
Download ID Code.....	7
Calibrating Proportional Controls.....	9
Diagnostics—T300 Transmitter .....	10
Diagnostics—R160 Receiver.....	11
Troubleshooting Guide .....	12
Parts & Accessories.....	16
Specifications.....	16
Warranty Information .....	16

**NOTE:** These instructions are intended only for installing and operating the remote control equipment described here. This is not a complete Operator's Manual. For complete operating instructions, please read the Operator's Manual appropriate for your particular machine.

## Safety Precautions

### READ ALL INSTRUCTIONS

**CAUTION:** Changes or modifications not expressly approved by the party responsible for compliance could void the user's authority to operate the equipment.

Failure to follow the SAFETY PRECAUTIONS may result in radio equipment failure and serious personal injury

#### Installation

PROVIDE A SAFETY CUTOFF SWITCH. If maintenance is required, the radio must be disconnected from power  
USE PROPER WIRING. Loose or frayed wires can cause system failure, intermittent operation, machine damage, etc.  
DO NOT INSTALL IN HOT AREAS. This apparatus can be damaged by heat in excess of 158°F (70°C)

#### Personal Safety

MAKE SURE MACHINERY AND SURROUNDING AREA IS CLEAR BEFORE OPERATING. Do not activate the remote system unless it is safe to do so.

TURN OFF THE RECEIVER POWER BEFORE WORKING ON MACHINERY. Always disconnect the remote system before doing any maintenance to prevent accidental operation of the machine

#### Care

KEEP DRY. Do not clean the transmitter / receiver under high pressure. If water or other liquids get inside the transmitter battery or receiver compartment, immediately dry the unit. Remove the case and let the unit air dry

CLEAN THE UNIT AFTER OPERATION. Remove any mud, dirt, concrete, etc. from the unit to prevent clogging of buttons, switches, etc. by using a damp cloth.

#### Maintenance / Welding

DISCONNECT THE RADIO RECEIVER BEFORE WELDING on the machine the receiver is connected to. Failure to disconnect will result in the destruction of the radio receiver.

## System Overview

The **ORIGA T300 / R160** is a portable, long range, programmable radio remote control system. Designed as a compact and easy-to-use product, this member of the **ORIGA** family puts complete control of your crane where it's needed most, with the operator. It's robust, easy to install and has complete self-diagnostics. This system can be a simple cable replacement or add intelligence to make it a total control package. It's a radio, a PLC and a valve driver all in one.

The **ORIGA T300 R160** system uses Frequency Hopping Spread Spectrum (FHSS) technology. FHSS devices concentrate their full power into a very narrow signal that randomly hops from frequency to frequency within a designated band. This transmission pattern, along with CRC-16 error-checking techniques, enables signals to overcome interference that commonly affects licensed radios.

The **R160 receiver** is designed to be powered from a 12VDC or 24VDC system. It features 19 solid state, high-side driver input / output controls and a reliable E-Stop control.

The **T300 transmitter** comes with up to sixteen proportional and sixteen digital controls. The T300 can accommodate up to eight single axis paddles, eight three-position switches and a re-settable E-Stop. A unique ID code is used by each T300 to ensure that no two systems will conflict on a job site.

### Features

- FCC, ISC, CE approved
- License free
- 1200 foot range @ 900 MHz (900 ft @ 2.4 GHz)
- Compact / weatherproof / ergonomic
- Simple "wire-and-use" installation
- Resilient to impact and shock
- Available in both 900 MHz and 2.4 GHz
- Available with paddles and/or joysticks for proportional control
- Available with an optional pendant cable
- Factory configurable for all custom applications.



R160 Receiver

### T300 Dimensions and Controls

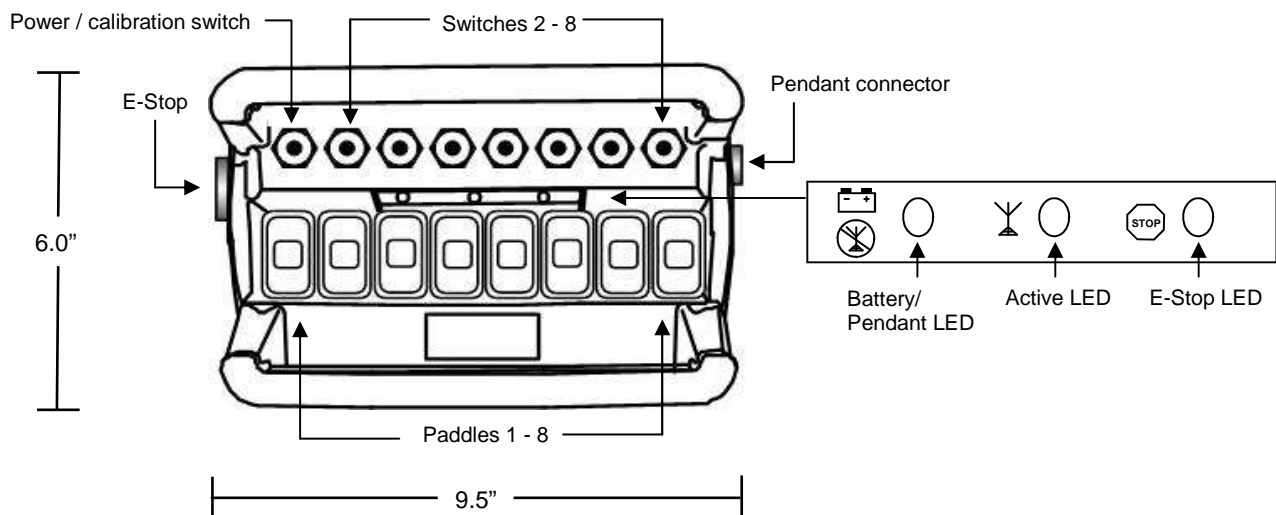

## Installing the Receiver

Use the **Wiring Diagram** and the **Connector Diagram** below to connect the receiver pins directly to the appropriate contacts of the machine electronics. R160 Output Cables can be provided with every system to simplify the wiring process. The Wire Color column below only applies to the OMNEX Output Cable configuration. Tips on mounting, power connections and filtering are also provided under **Installation Considerations**.

### Wiring Diagram

Pin-Output	Wire Colors	Functions
B7		Factory Configurable Only
B8		Factory Configurable Only
B12 - 19	Black/Red	Unused
B11 - 18	White/Black	Unused
B10 - 17	Blue/White	Unused
A1 - 16	Blue/Black	Unused
A2 - 15	Black/White	Unused
A4 - 14	Green/Black	Proportional Voltage Output (0-9.1VDC)
B9 - 13	Red/White	Unused
B6 - 12	Orange	BLADE GUIDE LEFT (Digital Output)
B5 - 11	White	BLADE GUIDE RIGHT (Digital Output)
B4 - 10	Green/Black/White	HEAD TRAVEL REV (Digital Output)
B3 - 9	Green	HEAD TRAVEL FWD (Digital Output)
B2 - 8	Red/Black/White	HEAD UP (Digital Output)
B1 - 7	White/Red/Black	HEAD DOWN (Digital Output)
A12 - 6	Orange/Red	DEBARKER OUT (Digital Output)
A10 - 5	Orange/Black	DEBARKER IN (Digital Output)
A11 - 4	Blue/Red	DEBARKER ON (Digital Output)
A9 - 3	White/Red	DRAG BACK DOWN (Digital Output)
A8 - 2	Red/Green	DRAG BACK UP (Digital Output)
A7 - 1	Orange/Green	BLADE ON (Digital Output)
A5	Black/White/Red	Switches to Power with Link
A6	Red	Power Input (+9V to 30VDC)
A3	Black	Ground

**Outputs:** 19 solid state, high-side driver outputs, 5A max. each, total combined current 15A  
**Inputs:** All output pins can be factory configured as inputs.

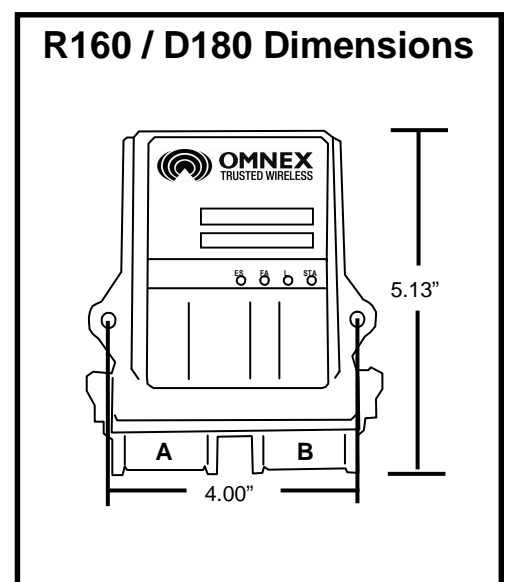
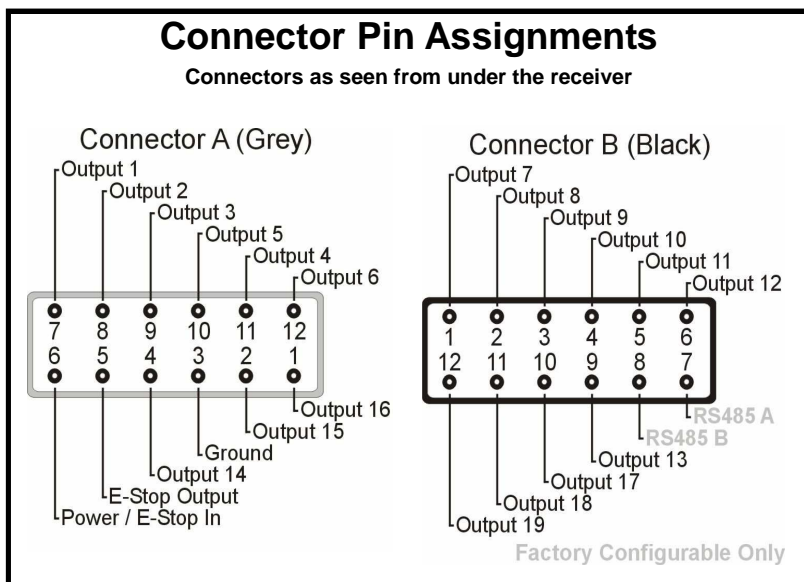

## Special Functions

The DEBARKER ON output is only enabled while the HEAD TRAVEL FWD output is on.

The Feed Speed Control Pot controls :  
Output 14—0 to 9.1VDC

## Installation Considerations

**NOTE:** The FCC and ISC require that the antenna be restricted to that supplied by the manufacturer and approved for use with this product. An optional OdB coax wire antenna may be supplied. For other antenna options, please contact OMNEX Control Systems ULC

### Mounting and Installation

The receiver can be mounted by fastening two ¼” bolts through the two mounting holes in the unit’s enclosure. When mounting, ensure that the receiver is oriented so that the text is reading right and the connectors pointing “down”.

When selecting a mounting point for the receiver, it is recommended that the location require only a minimal length of wiring to connect it to the control panel, that it will be in a visible area where it has good exposure to the operator and that it is mounted on a surface that sustains minimal vibration. It is also recommended that the receiver have the best possible line of sight with the transmitter

### Power Connections and Wiring

Whenever a power connection is made to an electronic device, it is a good practice to make both the Power (+) and Ground (-) connections directly to the Battery and avoid connecting the power from the charging side of existing wiring or making use of existing "ACC" or other peripheral connection points.

Make sure that wire of sufficient gauge and insulator type is used when connecting the outputs of the receiver to the control panel. Observe any component manufacturer’s instructions and recommendations for proper integration of their product. This includes the power ratings and requirements of such components as relays, valves, solenoids, etc.

Be sure to test each of the outputs with a multi-meter prior to connecting the outputs to your end devices. This will ensure that each output has been programmed to operate in the manner required by each end device.

### Filtering and Noise Suppression

Whenever a solenoid or electromagnetic switch is controlled by the receiver, it is a good practice to install a Diode across its terminals to ensure that surges and spikes do not continue back into the circuit. Appropriate 36V Bi-directional Diodes kits can be ordered under the OMNEX part number “AKIT-2492-01”.

## Power the Transmitter

### 1. Install the batteries in the transmitter

Batteries are installed in the transmitter by removing the battery cover using a slotted screwdriver and inserting 4 “C” alkaline batteries. Orientation of the batteries is embossed inside the battery housing. No batteries are required when the transmitter is connected to the receiver by a Pendant cable.

**NOTE:** For operation at temperatures below –10°C lithium batteries are recommended. Low temperatures reduce battery performance for both alkaline and lithium types. Refer to the battery manufacturer’s specifications for detailed information on low temperature performance.



Transmitter Battery Housing

### 2. Turn on the transmitter

Ensure all transmitter switches and paddles are in the neutral position. Turn on the transmitter by, pressing and releasing the [Power] switch The RED (E-Stop) light will flash quickly. Release the [E-Stop], the yellow (Active) light on the transmitter will begin to flash.

**WARNING:** do not install batteries backwards, charge, put in fire, or mix with other battery types. May explode or leak causing injury. Replace all batteries at the same time as a complete set and do not mix and match battery types.

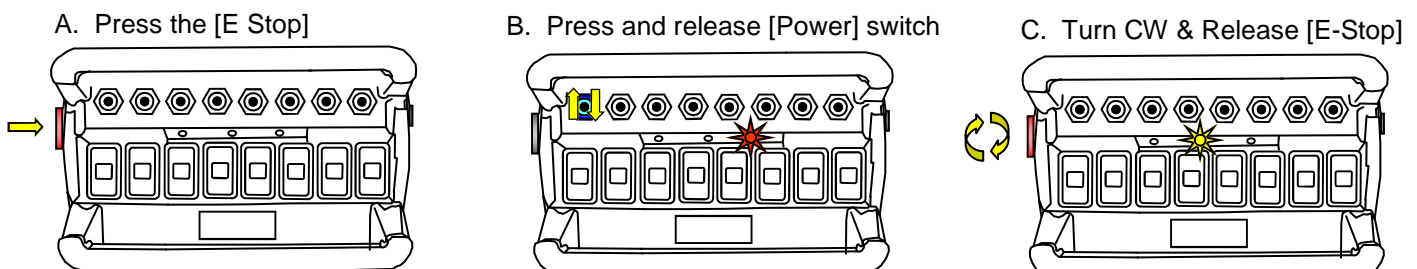

<b>Light Legend</b>	Solid		Slow Flash		Fast Flash		Red Light		Green Light		Yellow Light		Alternating Red & Green Light	

## Test the Transmitter / Receiver Link

Follow these steps to ensure that there is a Radio Link between the transmitter and receiver

Refer to the Light Legend below for diagram details

### 1. Press [E-Stop]

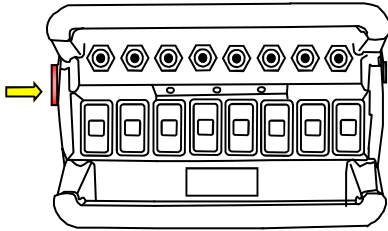

### 2. Power the R160

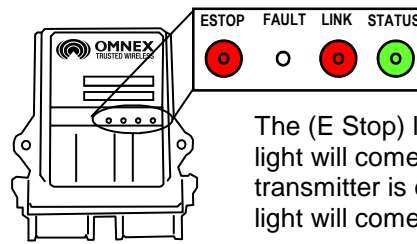

The (E Stop) light and the (Link) light will come on RED (provided the transmitter is off), and the (Status) light will come on GREEN.

### 3. Power the T300

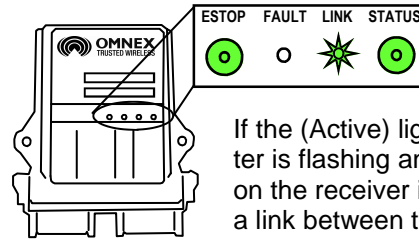
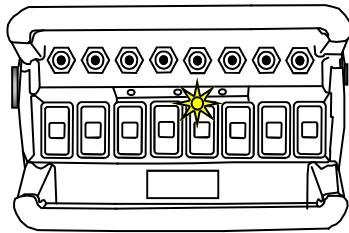

If the (Active) light on the transmitter is flashing and the (Link) light on the receiver is flashing GREEN, a link between the two exists.

**NOTE:** The transmitter will shut itself off (and the receiver will then shut off all outputs) after 10 minutes of inactivity as a battery saving feature. To restart the timer before the transmitter shuts off automatically, momentarily operate any toggle switch or paddle.

**The ORIGA System is now ready for use.**

If the receiver's (Link) light does not become GREEN follow the steps under **Download ID Code**.

## Download ID Code (Use in case of Link Test failure)

Follow these steps to download the transmitter's unique ID Code into the receiver. This will allow the receiver to establish a Radio link with a specific transmitter. Refer to **Troubleshooting Chart #4** for Tips and Considerations

**NOTE:** It is necessary to download the ID code when replacing either the transmitter or the receiver.

**NOTE:** If the transmitter is connected to the receiver with a Tether Cable, completing **only steps 4 and 6** is necessary (it is not necessary to open the R160 case and press the Setup button).

### 1. Opening the R160 Case

The cap is held on by two plastic tabs at opposing sides, which can be unlatched as shown using a screwdriver. Once the cap is free, the R160 can slide open.

Use a small slotted screwdriver to press the Side Tabs inward.

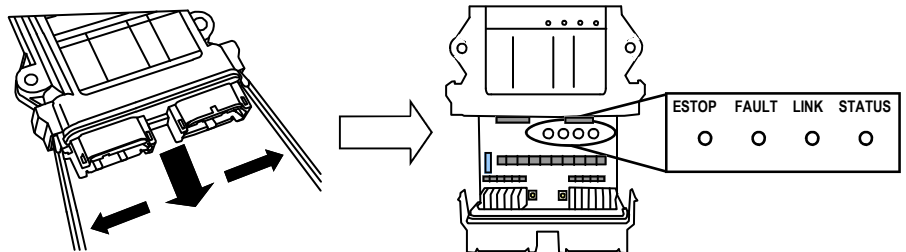

**NOTE:** When replacing the receiver cover, ensure the cover snaps completely into place to create a weather proof seal around the base of the receiver.

### 2. Prepare T300

A. Press [E-Stop]

B. Twist CW & release [E-Stop]

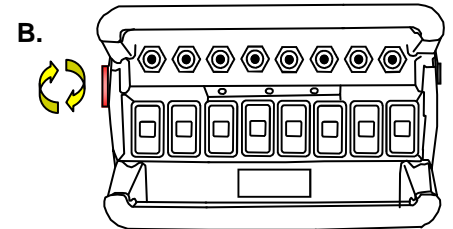
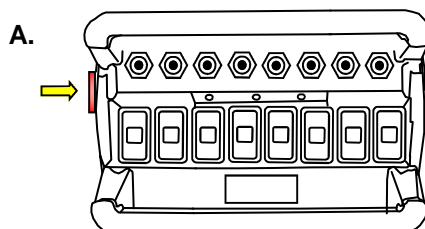

### Light Legend

Solid		Slow Flash		Fast Flash		Red Light		Green Light		Yellow Light		Alternating Red & Green Light	
-------	--	------------	--	------------	--	-----------	--	-------------	--	--------------	--	-------------------------------	--

## Download ID Code (Use in case of Link Test failure)

### 3. Power R160

- A. Supply power to the receiver. The (E-Stop) light and the (Link) light will come on RED and the (Status) light will come on GREEN

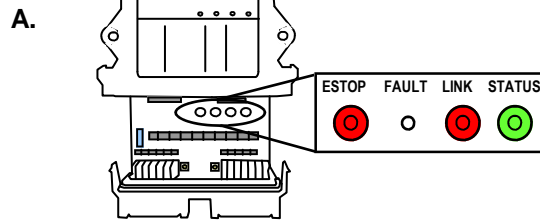

**NOTE:** For this document, orientation of the paddle and switch operation will be defined as follows:  
 Paddle UP—is towards the switches  
 Paddle DOWN—is away from switches  
 Switch UP—is away from paddles  
 Switch DOWN—is towards the paddles.

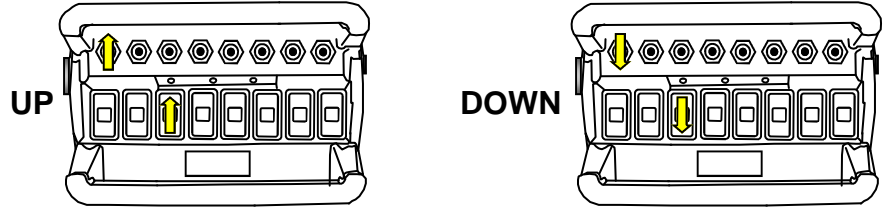

### 4. Power T300 into Configuration Mode

- A. Hold [Power] switch UP  
 B. Press [E-Stop]  
 C. Twist CW & release [E-Stop]  
 D. Release [Power] Switch

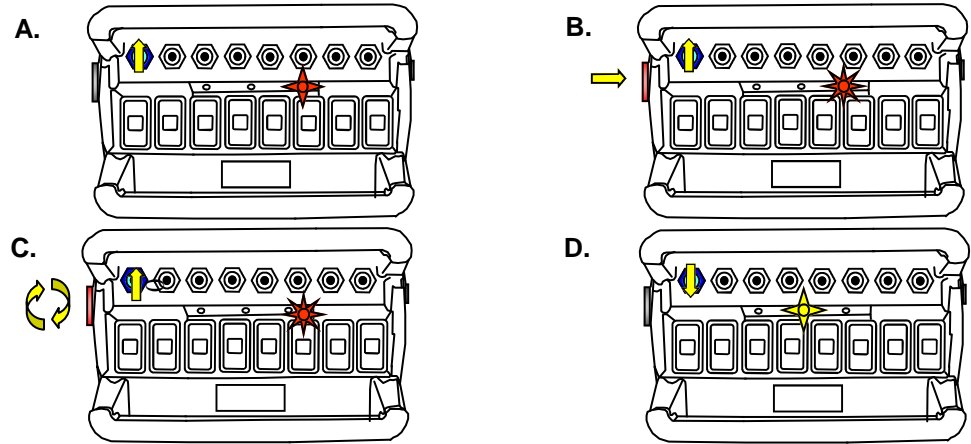

### 5. Put R160 into Setup Mode

- A. Press & hold [Setup] button until (Status) light goes from slow flash to fast flash  
 B. Release [Setup] button. (Status) light goes to solid GREEN, (Link) light turns off

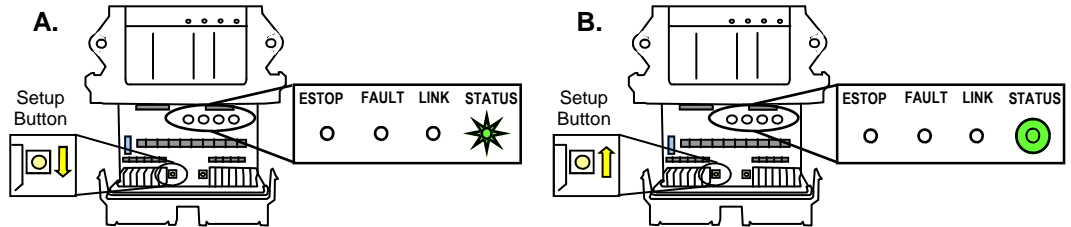

**NOTE:** If left idle in Setup Mode for over 30 seconds, the receiver will time out. The (Link) light and (Status) light will flash RED rapidly. To return to Setup Mode, repeat step 5.

### 6. Download ID Code

**NOTE:** When downloading a new ID to a receiver, a safety feature requires that the transmitter be in close proximity to the receiver. This will prevent a transmitter from accidentally reprogramming a different receiver in the area.

- A. Press [Power] switch UP and release  
 B. (Link) light goes to GREEN. Once complete, (Link) light goes to RED as the trans-

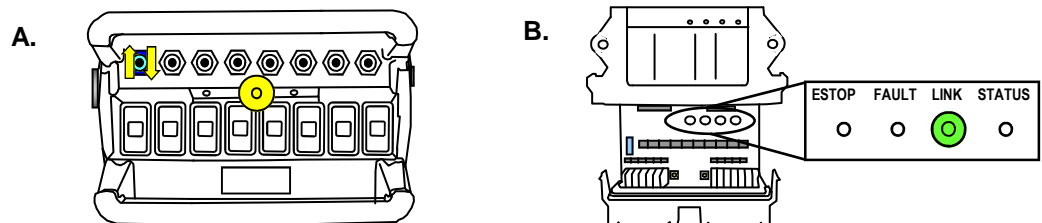

Light Legend	Solid	Slow Flash	Fast Flash	Red Light	Green Light	Yellow Light	Alternating Red & Green Light
--------------	-------	------------	------------	-----------	-------------	--------------	-------------------------------



# Calibrating Proportional Controls

The transmitter's Paddles and Potentiometers control the receiver's proportional output. The Paddles/Joysticks are used in conjunction with any of the transmitter's switches. The proportional output can be activated when a switch is held UP or DOWN; it will become active at an increasingly high level as the Paddle/Joystick is pushed/pulled, or a potentiometer is adjusted. The minimum and maximum levels of the proportional output can be calibrated by following these steps. Refer to the **Light Legend** below for diagram details.

**NOTE:** Calibration settings can be reset to factory default in steps 3 & 4 by holding the [Power] switch UP or DOWN for 5 seconds.

## 1. Power T300, Power R160

- A. Refer to steps in "Power the Transmitter"
- B. Supply power to the R160

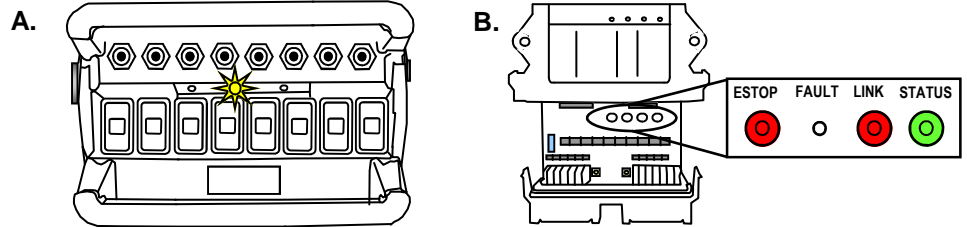

## 2. Setup T300 into Configuration Mode

- A. Hold [Power] switch DOWN for 5 seconds until the (Battery) LED goes to alternating RED and YELLOW.
- B. Release [Power] switch

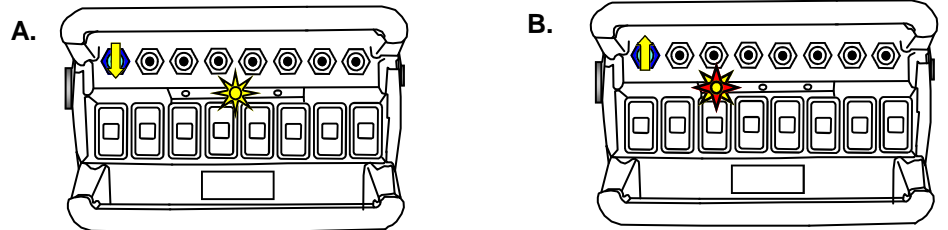

## 3. Set Minimum Level

- A. Push the paddle (or turn the potentiometer) in the direction you wish to calibrate until the (Active) LED comes on
- B. Hold paddle and Press [Power] switch DOWN to increase minimum level or UP to decrease it

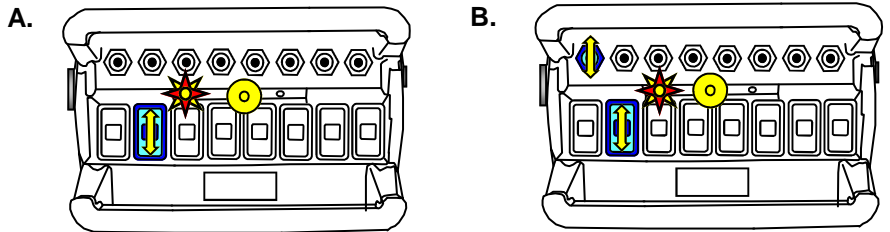

## 4. Set Maximum Level

- A. Fully push the paddle (function) (or turn the potentiometer) in the direction you wish to calibrate until the (E-Stop) LED comes on.
- B. Hold paddle and Press [Power] switch DOWN to increase maximum level or UP to decrease it

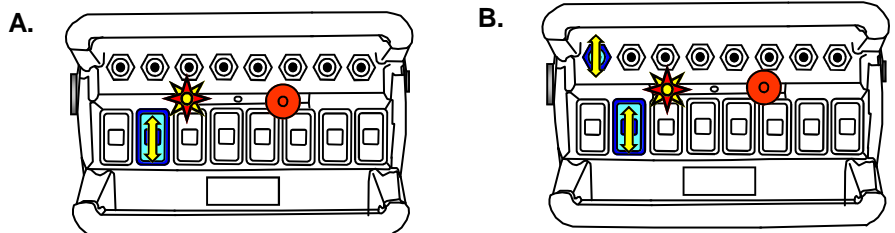

**Note:** Repeat steps 3 and 4 for each paddle (function) that needs to be calibrated.

## 5. Power Off

- A. Press [E-Stop]

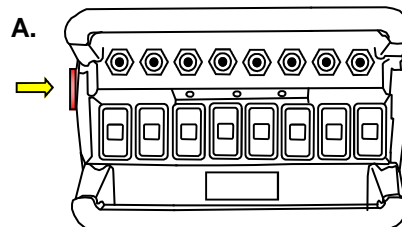

Light Legend	Solid	Slow Flash	Fast Flash	Red Light	Green Light	Yellow Light	Alternating Red & Yellow Light

## Diagnostics—T300 Transmitter

	Tether connection detected
	Low battery. Unit will run approximately 20 hours after Battery light starts flashing.
	The transmitter is in Calibration mode
	Power switch is stuck in the “UP” position.
	The Active light remain on momentarily when a function is activated (i.e. a switch or paddle is triggered). This is normal operation.
	<b>Normal Operation</b> The transmitter is in Download Mode.
	<b>Normal Operation</b> The Active light will flash 2 times per second, indicating that the transmitter is sending signals to the receiver.
	Stuck switch detected. Ensure that all switches are in a centered position. The transmitter will not power up when a function is ON.
	<b>On Power Up</b> Release the E-Stop button within 10 seconds to power up the transmitter, or the unit will power down.
	<b>On Power Up</b> Press and release the E-Stop button within 10 seconds to power up the transmitter, or the unit will power down.

## Diagnostics - D180 Expansion Module

### Indicator lights for the D180 Expansion Module

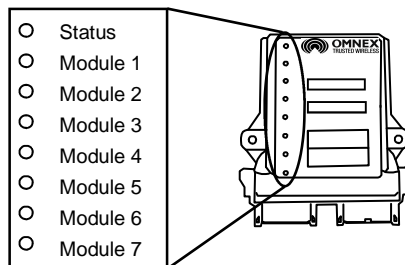

#### Status Indicator

STATUS	Module is operating properly	STATUS	Low battery condition detected
STATUS	There is a fault with the module	STATUS	Fuse blown
STATUS	Communication to the module is active		

#### Module 1-7 Indicators

MODULE	Module is installed and operating properly	MODULE	There is a short to supply
MODULE	There is a short to ground / over current	MODULE	No Module installed

#### Light Legend

Solid	Slow Flash	Fast Flash	Red Light	Green Light	Yellow Light	Alternating Red & Yellow Light
-------	------------	------------	-----------	-------------	--------------	--------------------------------

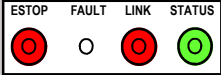
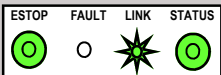
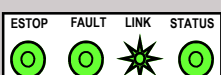
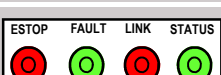

# Diagnostics - R160 Receiver

## Normal Operation

	Transmitter is OFF If the transmitter is off, the receiver is operating properly.
	Transmitter is ON When the transmitter is turned on, the Link light (fast flashing) and E-Stop (GREEN) indicates the receiver is operating properly
	Transmitter is in Operation When a function is activated on the transmitter, the Fault light will turn on GREEN. This indicates the receiver is operating properly
	Transmitter is OFF When a latched function is activated then the transmitter is turned off, the Fault light will stay on GREEN. If the system was intentionally designed this way, the receiver is operating properly, if not call for service.

## Trouble Indicators

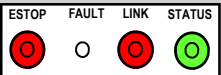
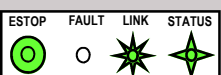
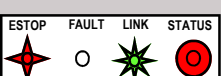
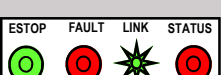
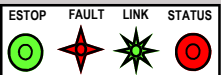
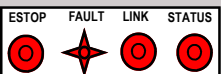
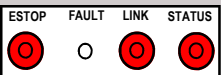
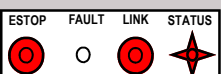
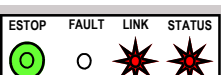
**Note:** In some cases, the indicator lights will be different depending on whether the transmitter is on or off. Please note the transmitter status in the "Description" column for each case.

Indicator Lights	Description	Solution
	Transmitter is ON The reason is the transmitter is not communicating with the receiver.	Refer to <b>Troubleshooting Chart #3</b> for solutions
	Transmitter is ON A low battery condition has been detected.	To detect intermittent conditions caused by poor or corroded ground or power circuits, the GREEN light will continue to flash for 30 seconds after the condition has been removed.
	Transmitter is ON An internal fault with the E-Stop has been detected.	Inspect E-Stop wiring for short circuit. Disconnect E-Stop wire as close to the receiver output as possible. If the Status light changes to: <ul style="list-style-type: none"> <li>• GREEN, a short occurs after disconnection point.</li> <li>• Stays flashing RED, send it in for service .</li> </ul>
	Transmitter is ON A short to ground or excessive current draw on an output. It is most likely caused by a wiring fault.	Ensure transmitter is functioning properly, check status of each output connection: Press each function button and observe Fault Light. <ul style="list-style-type: none"> <li>• If GREEN, everything is OK.</li> <li>• If RED, there is a short in that connection.</li> </ul>
	Transmitter is ON The E-Stop output has been connected with one of the other outputs	Follow the wire and check for connections with other wires, disconnect to see if condition clears. If not, call for service.
	Transmitter is OFF A wiring short to the battery has been detected.	Refer to <b>Troubleshooting Chart #1</b> for solutions
	Transmitter is OFF The receiver has detected an internal fault.	Refer to <b>Troubleshooting Chart #1</b> for solutions
	Transmitter is OFF Blown fuse detected.	Refer to <b>Page 7</b> for instructions on how to open the receiver case to access fuse. Check wiring for shorts or bare spots. If fuses continue to blow, call for service.
	Transmitter is ON A setup failure has occurred.	Either hold the Setup button for 5 seconds to return to Setup mode or cycle power to return to the normal operating mode.
	Transmitter is OFF The receiver is powered incorrectly.	Most likely cause of this condition is that an output wire or the E-Stop wire has been connected to the power supply while the power wire is disconnected from the power supply.

Light Legend	Solid 	Slow Flash 	Fast Flash 	Red Light 	Green Light 	Yellow Light 	Alternating Red & Green Light 
--------------	-------------------------------------------------------------------------------------------	------------------------------------------------------------------------------------------------	------------------------------------------------------------------------------------------------	-----------------------------------------------------------------------------------------------	---------------------------------------------------------------------------------------------------	----------------------------------------------------------------------------------------------------	---------------------------------------------------------------------------------------------------------------------

Test the Receiver—R160

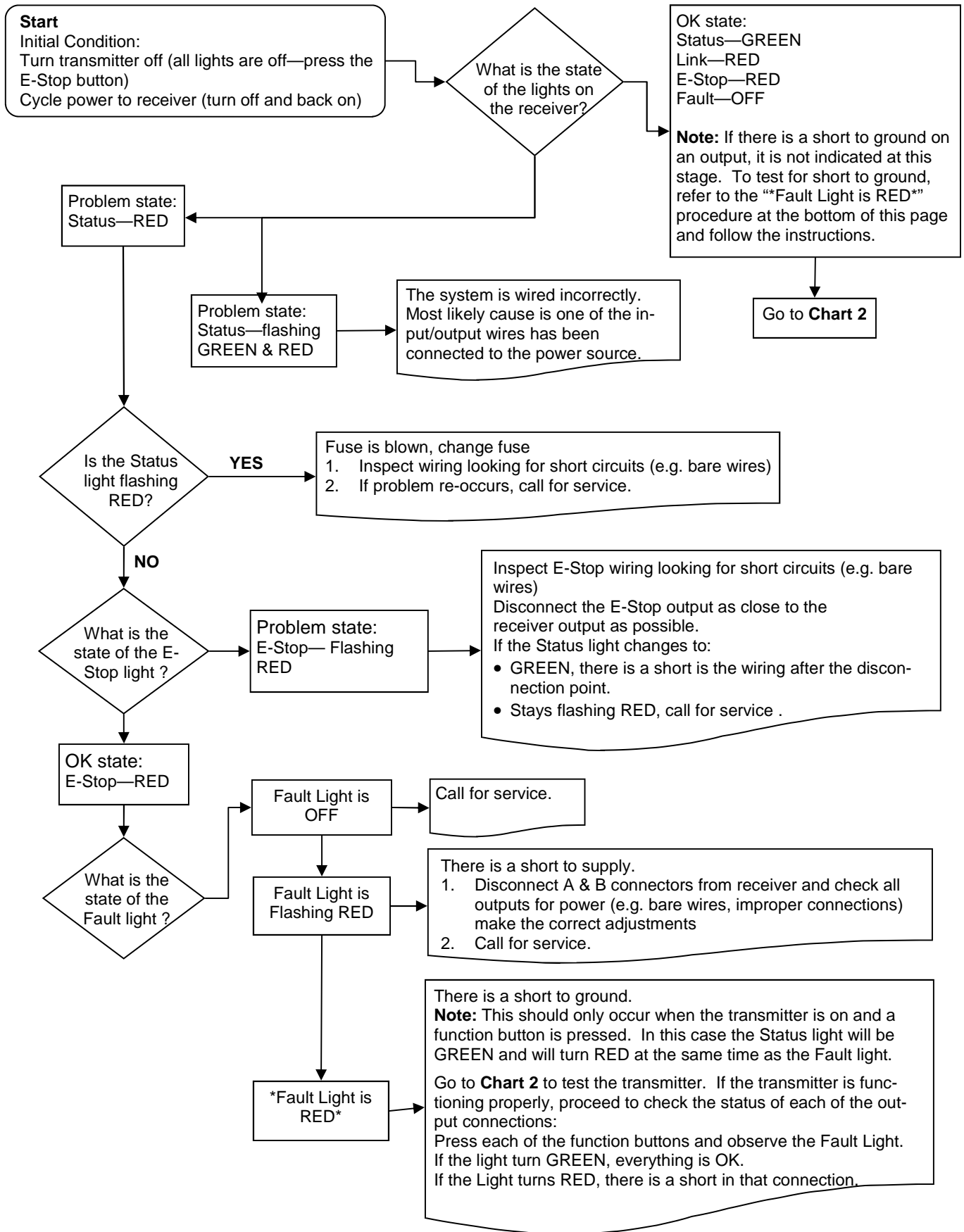

**Test the Transmitter—T300**

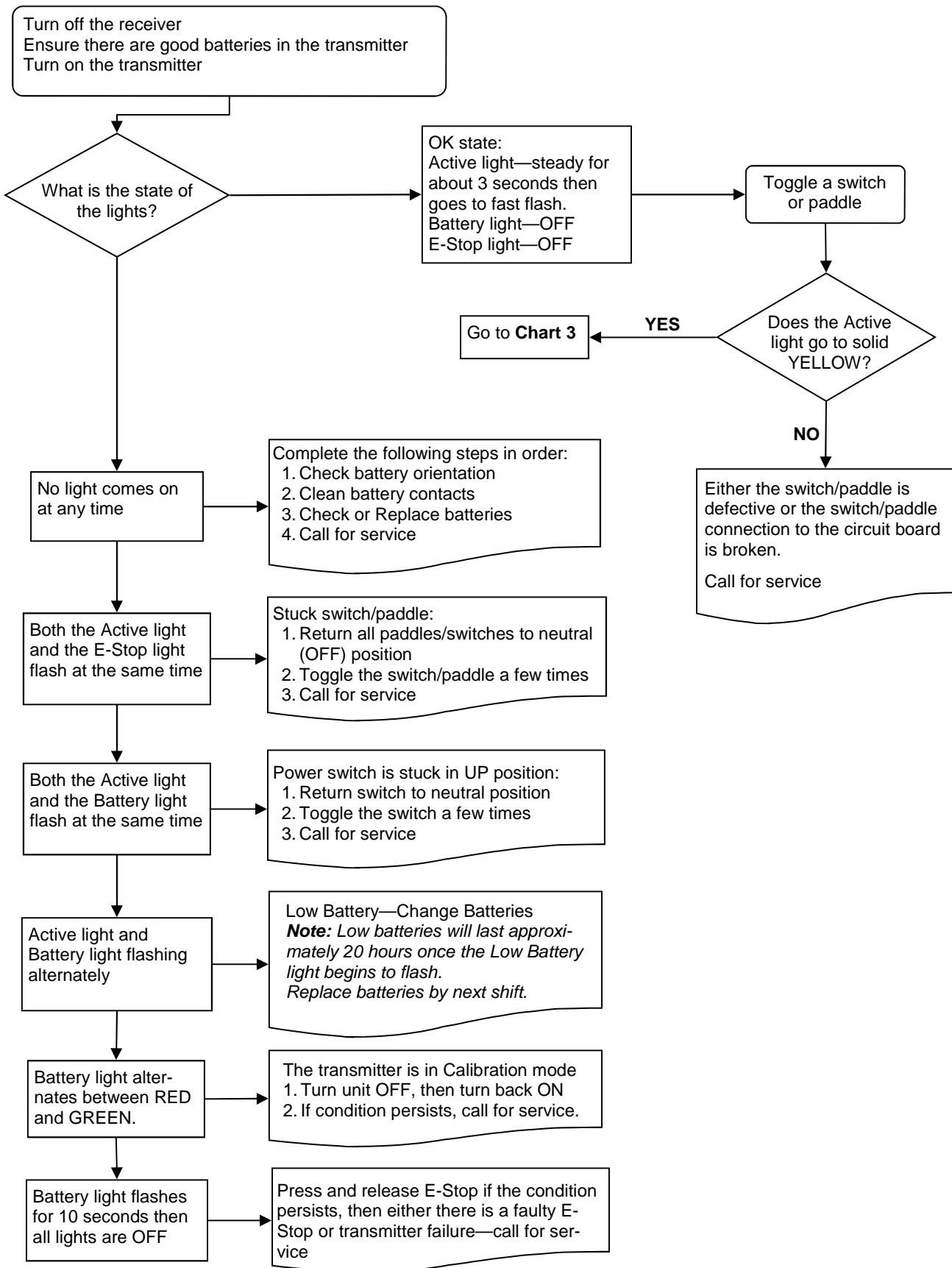

Testing the Transmitter / Receiver Communication

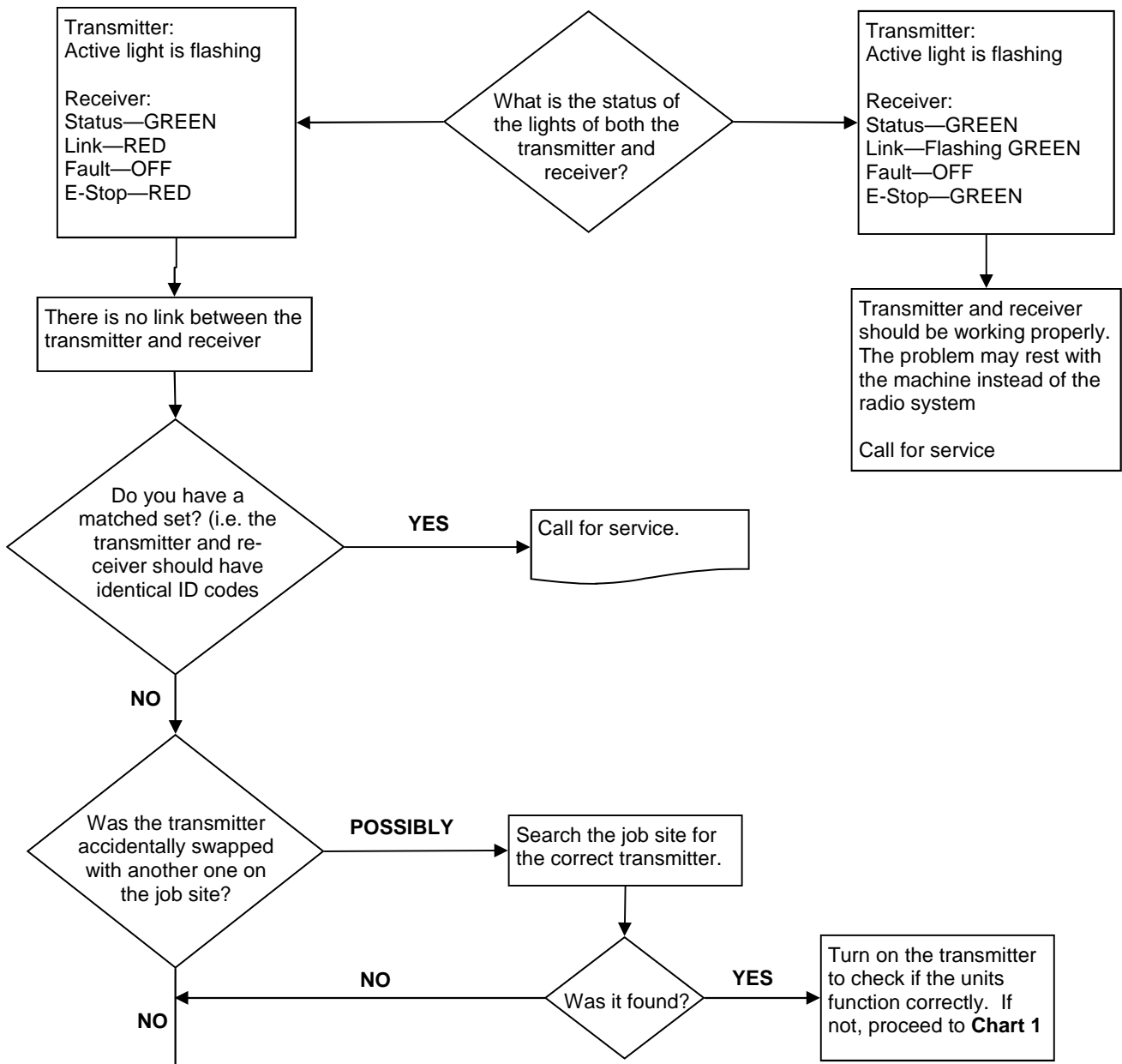

**!!Caution!!**

**Note:** Before you proceed with the Download ID procedure located on **Page 7 & 8**, great care and caution must be adhered to. Also, refer to **Chart #4** for Tips and Considerations.

If by accident, the transmitters have been switched with another unit, by downloading the ID code to a new receiver, it is possible for the transmitter to operate 2 units at the same time (if the original receiver unit is still on the job site). Therefore it must be certain that the transmitter / receiver pair are the correct set.

Secondly, once the download procedure is completed, ensure all other units on the job site are stopped. Test the operation of the newly configured set to ensure no other machines on the site work with the same transmitter.

Once you are certain that the transmitter / receiver pair are a unique set, continue normal operations.

## Considerations when Downloading the ID

### Potential downloading issues

If testing of the receiver and transmitter both show the system as working (Chart 1 & 2), then the transmitter and receiver will both go into Download/Configuration mode.

Possible issues could arise during Step 4, the download phase of reprogramming. In this case there are 2 symptoms to look for:

1. The Link light on the receiver will not turn GREEN when the power switch is toggled on the transmitter to download
2. The receiver will "time out" indicating that it didn't receive a signal from the transmitter within the 30 seconds from the time the receiver was put into Setup Mode.

If all indications appear normal during the download phase, test the link by turning on the transmitter (note: the transmitter shuts off after transmitting the ID code in Step 4)

1. If the Link light on the receiver doesn't turn GREEN, the receiver didn't receive all of the information that was sent from the transmitter.

### Possible Solutions

1. Try the Downloading steps again
2. If this doesn't correct the problem, send both the transmitter and receiver in for service.

**Note:** you could try to determine whether the fault lies with the transmitter or receiver by completing the downloading procedure with a different transmitter. If this step works, then the fault lies with the original transmitter. If not, the fault may lie with the receiver.

### !!Caution!!

**Note:** Before attempting downloading with another transmitter, understand that reprogramming the receiver with another transmitter, could result in two receivers on the job site responding to the one transmitter. If the original transmitter was sent in for repair, Disconnect the receiver (disconnect connector A) to continue using the machine without remote capability and without fear of inadvertently operating the machine with the other transmitter.

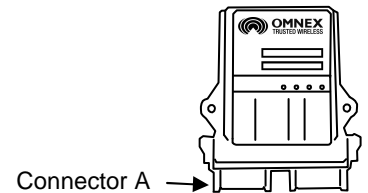

### Reprogramming Tips:

1. Use a pointy instrument to depress the Setup button on the receiver (i.e. a pen) as the button is relatively small
2. Follow each step as laid out in the procedure
3. Never lay the receiver circuit board down on anything metallic (there are contact points on the back which could contact the metal and damage the receiver)

## Parts & Accessories

Part	OMNEX Part Number	Description
Batteries	B0012	4 x "C" alkaline
Fuse	F0039	36V Bi-directional, Bussman ATC-15
Shoulder Strap	FMEC-2709-01	T300 Tear-away shoulder strap
Output Cable	ACAB-2493-01	R160 Output Cable, Generic
	ACAB-2493-03	R160 Output Cable, Generic, Tethered
Pendant Cable	ACAB-2455-01	Tether Cable, 10m
	ACAB-2455-02	Tether Cable, 8m
	ACAB-2710-01	Tether Cable, 4-12ft
Connector Kit	AKIT-2337-01	Includes Deutsch socket connectors, wedges, pins and sealing plugs
Bipolar Diode Kit	AKIT-2492-01	Motorola P6KE36CA



Shoulder Strap



Pendant Cable



Pendant Coil



R160 Output Cable

## Specifications

	R160 Receiver	T300 Transmitter
Size	5.1" x 4.7" x 1.4" (130mm x 119mm x 36mm)	9.5" x 6.0" x 5.0" (240mm x 152mm x 127mm)
Weight	0.65lbs (0.295kg)	3.5 lbs (incl. batteries) (1.2kg)
Construction	High impact plastic, weatherproof	High impact, low temperature plastic, weatherproof
Input Power	+9V to 30VDC	4C alkaline batteries
Battery Life	N/A	500 hours (continuous use)
Operating Temperature Range	-40F to 158F (-40C to 70C)	-40F to 140F (-40C to 60C)
Outputs	3A (max) each (sourcing), 10A (max) each (combined)	N/A
Antenna	Internal	Internal
Approvals	USA- FCC part 15.247 Australia- C-Tick	Canada- ISC RSS 210 Issue 6, Sept. Europe- EN 440

### FCC Rules and Compliance

This device complies with Part 15 of the FCC Rules. Operation is subject to the following two conditions: (1) This device may not cause harmful interference, and (2) this device must accept any interference received, including interference that may cause undesired operation.

FCC Part 15.247  
ISC RSS 210 Issue 6, Sept. 2005

### Warranty

OMNEX Control Systems ULC warrants to the original purchaser that the OMNEX products are free from defects in materials and workmanship under normal use and service for a period of ONE YEAR, parts (EXCLUDING: SWITCHES, CRYSTALS, OR PARTS SUBJECT TO UNAUTHORIZED REPAIR OR MODIFICATION) and labor from the date of delivery as evidenced by a copy of the receipt. OMNEX's entire liability and your exclusive remedy shall be, at OMNEX's option, either the (a) repair or (b) replacement of the OMNEX product which is returned within the warranty period to OMNEX freight collect by the OMNEX APPROVED carrier with a copy of the purchase receipt and with the return authorization of OMNEX. If failure has resulted from accident, abuse or misapplication, OMNEX shall have no responsibility to repair or replace the product under warranty. In no event shall OMNEX be responsible for incidental or consequential damage caused by defects in its products, whether such damage occurs or is discovered before or after replacement or repair and whether or not such damage is caused by the negligence of OMNEX Control Systems ULC.

### OMNEX Control Systems ULC

74-1833 Coast Meridian Road  
Port Coquitlam, BC, Canada  
V3C 6G5

Tel: 604-944-9247  
Fax: 604-944-9267

**Toll Free: 1-800-663-8806**

[www.omnexcontrols.com](http://www.omnexcontrols.com)