

*OWNER'S MANUAL*

# **KOHLER**.COMMAND PRO

**CH940-980**

**HORIZONTAL CRANKSHAFT**

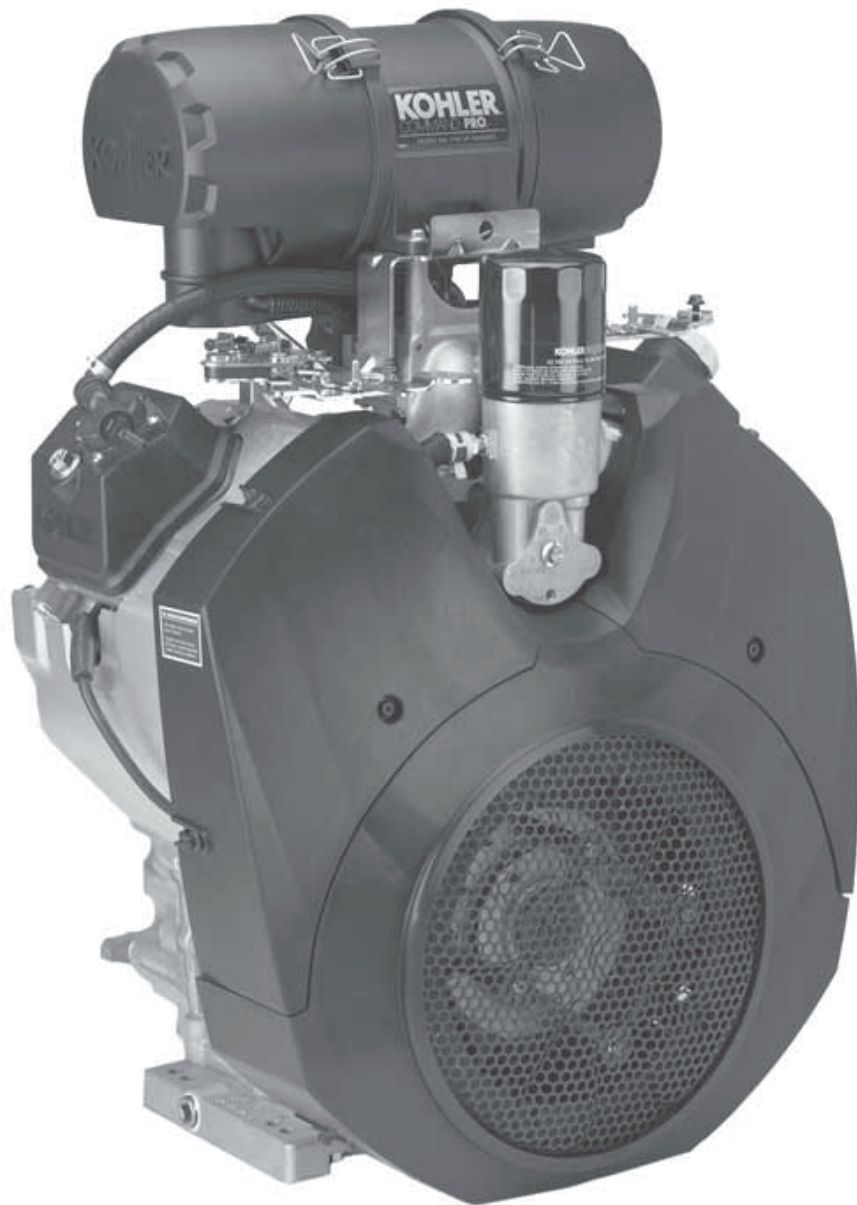

**KOHLER**  
ENGINES

## Safety Precautions

To ensure safe operations please read the following statements and understand their meaning. Also refer to your equipment owner's manual for other important safety information. This manual contains safety precautions which are explained below. Please read carefully.

### **WARNING**

Warning is used to indicate the presence of a hazard that *can* cause *severe* personal injury, death, or substantial property damage if the warning is ignored.

### **CAUTION**



Caution is used to indicate the presence of a hazard that *will* or can cause *minor* personal injury or property damage if the caution is ignored.

### **NOTE**

Note is used to notify people of installation, operation, or maintenance information that is important but not hazard-related.



### **For Your Safety!**

*These precautions should be followed at all times. Failure to follow these precautions could result in injury to yourself and others.*

|  |
|--|
|  <b>WARNING</b>                             |
|    |
| <b>Explosive Fuel can cause fires and severe burns.</b><br><br>Do not fill the fuel tank while the engine is hot or running. |



### **Explosive Fuel!**

Gasoline is extremely flammable and its vapors can explode if ignited. Store gasoline only in approved containers, in well ventilated, unoccupied buildings, away from sparks or flames. Do not fill the fuel tank while the engine is hot or running, since spilled fuel could ignite if it comes in contact with hot parts or sparks from ignition. Do not start the engine near spilled fuel. Never use gasoline as a cleaning agent.

|  |
|--|
|  <b>WARNING</b> |
|                |
| <b>Rotating Parts can cause severe injury.</b><br><br>Stay away while engine is in operation.    |



### **Rotating Parts!**

Keep hands, feet, hair, and clothing away from all moving parts to prevent injury. Never operate the engine with covers, shrouds, or guards removed.

|   |
|---|
|  <b>WARNING</b>          |
|                         |
| <b>Hot Parts can cause severe burns.</b><br><br>Do not touch engine while operating or just after stopping. |

### **Hot Parts!**

Engine components can get extremely hot from operation. To prevent severe burns, do not touch these areas while the engine is running, or immediately after it is turned off. Never operate the engine with heat shields or guards removed.

|  |
|--|
|  <b>CAUTION</b> |
|                 |
| <b>Electrical Shock can cause injury.</b><br><br>Do not touch wires while engine is running.       |

### **Electrical Shock!**

Never touch electrical wires or components while the engine is running. They can be sources of electrical shock.

|   |
|---|
| <b>California Proposition 65 Warning</b>  |
| <i>Engine exhaust from this product contains chemicals known to the State of California to cause cancer, birth defects, or other reproductive harm.</i> |

## Safety Precautions (Cont.)



|   |
|---|
|  <b>WARNING</b>                          |
|    |
| <b>Accidental Starts can cause severe injury or death.</b><br><br>Disconnect and ground spark plug lead before servicing. |

### Accidental Starts!

**Disabling engine. Accidental starting can cause severe injury or death.**



Before working on the engine or equipment, disable the engine as follows:

- 1) Disconnect the spark plug lead(s).
- 2) Disconnect negative (-) battery cable from battery.

|   |
|---|
|  <b>WARNING</b>  |
|    |
| <b>Carbon Monoxide can cause severe nausea, fainting or death.</b><br><br>Avoid inhaling exhaust fumes, and never run the engine in a closed building or confined area. |

### Lethal Exhaust Gases!

Engine exhaust gases contain poisonous carbon monoxide. Carbon monoxide is odorless, colorless, and can cause death if inhaled. Avoid inhaling exhaust fumes, and never run the engine in a closed building or confined area.

|  |
|--|
|  <b>WARNING</b>   |
|   |
| <b>Explosive Gas can cause fires and severe acid burns.</b><br><br>Charge battery only in a well ventilated area. Keep sources of ignition away. |

### Explosive Gas!

Batteries produce explosive hydrogen gas while being charged. To prevent a fire or explosion, charge batteries only in well ventilated areas. Keep sparks, open flames, and other sources of ignition away from the battery at all times. Keep batteries out of the reach of children. Remove all jewelry when servicing batteries.

Before disconnecting the negative (-) ground cable, make sure all switches are OFF. If ON, a spark will occur at the ground cable terminal which could cause an explosion if hydrogen gas or gasoline vapors are present.

**Congratulations** – You have selected a fine four-cycle, twin cylinder, air-cooled engine. Kohler designs long life strength and on-the-job durability into each engine...making a Kohler engine dependable...dependability you can count on. Here are some reasons why:

- Efficient overhead valve design and full pressure lubrication provide maximum power, torque, and reliability under all operating conditions.
- Dependable, maintenance free electronic ignition ensures fast, easy starts time after time.
- Kohler engines are easy to service. All routine service areas (like the oil filter, dipstick, oil fill, air cleaner, spark plug, and carburetor) are easily and quickly accessible.
- Parts subject to the most wear and tear (like the cylinder liner and camshaft) are made from precision formulated cast iron.
- Every Kohler engine is backed by a worldwide network of over 10,000 distributors and dealers. Service support is just a phone call away. Call 1-800-544-2444 (U.S. & Canada) for Sales & Service assistance.

To keep your engine in top operating condition, follow the maintenance procedures in this manual.

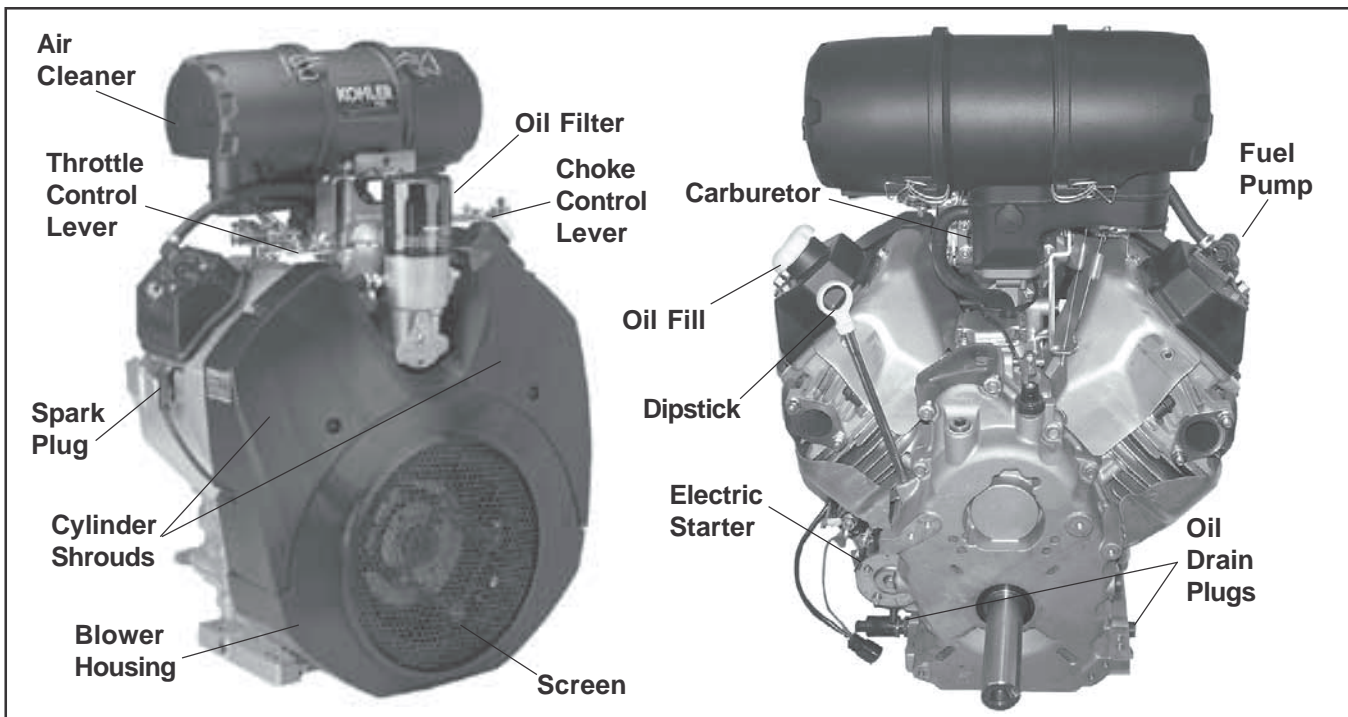

Figure 1. Typical Command PRO Horizontal Shaft Engine.

### Oil Recommendations

Using the proper type and weight of oil in the crankcase is extremely important. So is checking oil daily and changing oil regularly. Failure to use the correct oil, or using dirty oil, causes premature engine wear and failure.

### Oil Type

Use high quality detergent oil of **API (American Petroleum Institute) service class SG, SH, SJ or higher**. Select the viscosity based on the air temperature at the time of operation as shown in the following table.

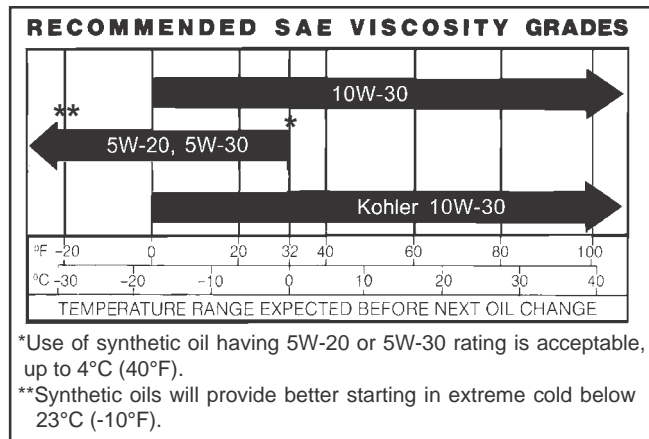

Figure 2. Viscosity Grades Table.

NOTE: Synthetic oils meeting the listed classifications may be used with oil changes performed at the recommended intervals. However to allow piston rings to properly seat, a new or rebuilt engine should be operated for at least 50 hours using standard petroleum based oil before switching to synthetic oil.

A logo or symbol on oil containers identifies the API service class and SAE viscosity grade. See Figure 3.



Figure 3. Oil Container Logo.

Refer to **Maintenance Instructions** beginning on page 8 for detailed oil check, oil change, and oil filter change procedures.

NOTE: Using other than service class SG, SH, SJ or higher oil or extending oil change intervals longer than recommended can cause engine damage.

## Fuel Recommendations

### **WARNING: Explosive Fuel!**

Gasoline is extremely flammable and its vapors can explode if ignited. Store gasoline only in approved containers, in well ventilated, unoccupied buildings, away from sparks or flames. Do not fill the fuel tank while the engine is hot or running, since spilled fuel could ignite if it comes in contact with hot parts or sparks from ignition. Do not start the engine near spilled fuel. Never use gasoline as a cleaning agent.

## General Recommendations

Purchase gasoline in small quantities that can be used within 30 days and store only in clean, approved containers. Do not use gasoline left over from the previous season unless treated with a fuel stabilizer (see **Storage**), to minimize gum deposits and ensure easy starting. Do not use gasoline containing Methanol, or add oil to the gasoline.

Do not overfill the fuel tank. Leave room for the fuel to expand.

## Fuel Type

For best results use only clean, fresh, **unleaded** gasoline with a pump sticker octane rating of 87 or higher. In countries using the Research method, it should be 90 octane minimum.

Unleaded gasoline is recommended as it leaves less combustion chamber deposits and reduces harmful exhaust emissions. Leaded gasoline is not recommended and **must not** be used in any models where exhaust emissions are regulated.

## Gasoline/Alcohol blends

Gasohol (up to 10% ethyl alcohol, 90% unleaded gasoline by volume) is approved as a fuel for Kohler engines. Other gasoline/alcohol blends including E20 and E85 are not to be used and not approved. Any failures resulting from use of these fuels will not be warranted.

## Gasoline/Ether blends

Methyl Tertiary Butyl Ether (MTBE) and unleaded gasoline blends (up to a maximum of 15% MTBE by volume) are approved as a fuel for Kohler engines. Other gasoline/ether blends are not approved.

## Engine Identification Numbers

When ordering parts, or in any communication involving an engine, always give the **Model, Specification, and Serial Numbers** of the engine.

The engine identification numbers appear on a decal affixed to the engine shrouding. Include letter suffixes, if there are any.

Record your engine identification numbers on the identification label below (Figure 4) for future reference.

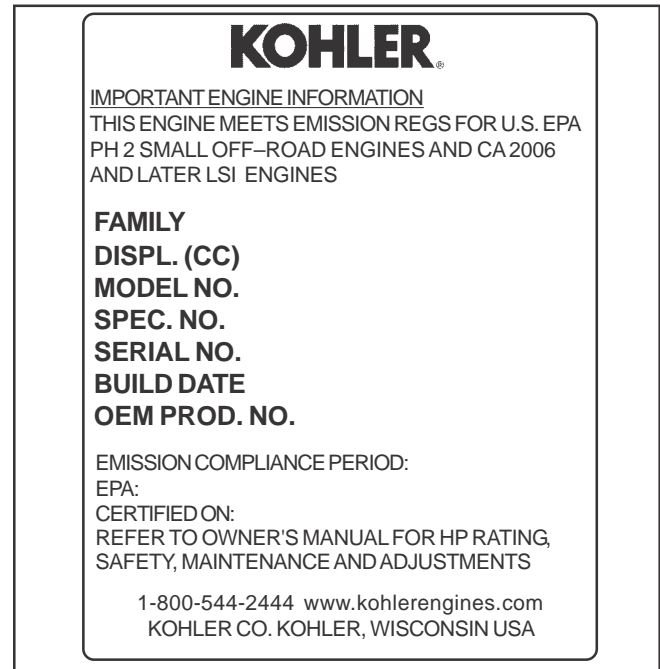

Figure 4. Engine Identification Label.

The Emission Compliance Period referred to on the Emission Control or Air Index label indicates the number of operating hours for which the engine has been shown to meet Federal emission requirements. The following table provides the Engine Compliance Period (in hours) associated with the category descriptor found on the certification label.

## Emission Compliance Period (Hours)

|     |                          |
|-----|--------------------------|
| EPA | Category A<br>1000 hours |
|-----|--------------------------|

Refer to certification label for engine displacement.

Exhaust Emission Control System for models CH940-980 is EM.

## Model Designation

Model CH980 for example: C designates Command engine, H designates horizontal crankshaft, and 980 indicates the numerical model designation. A letter suffix designates a specific version as follows:

|               |                   |
|---------------|-------------------|
| <b>Suffix</b> | <b>Designates</b> |
| S             | Electric Start    |

## Operating Instructions

Also read the operating instructions of the equipment this engine powers.

### Pre-Start Checklist

- Check oil level. Add oil if low. Do not overfill.
- Check fuel level. Add fuel if low.
- Check cooling air intake areas and external surfaces of engine. Make sure they are clean and unobstructed.
- Check that the air cleaner components and all shrouds, equipment covers, and guards are in place and securely fastened.
- Check that any clutches or transmissions are disengaged or placed in neutral. This is especially important on equipment with hydrostatic drive. The shift lever must be exactly in neutral to prevent resistance which could keep the engine from starting.

### Throttle and Choke Control Linkage Setup

The throttle and choke levers on these engines allow remote mounted control operation from either side. The linkage for the throttle and choke is connected in one of the two available hole locations; *A* or *B* in the control levers. Hole location *A* in each lever is used for **Outer Pull** actuation. Hole Location *B* used for **Inner Pull** actuation. Most engines will have the control linkage connected in Location *A*, the primary location. If the application requires opposite side control direction or function, unhook the link(s) from the small clip and reconnect in the other hole location. See Figures 5 and 6.

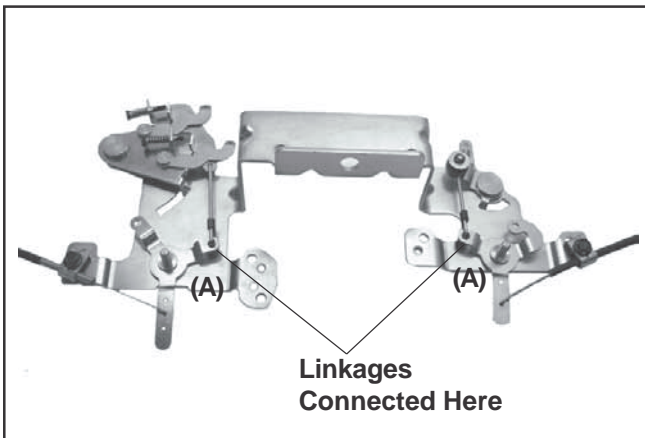

Figure 5. Throttle and Choke Control Linkage in "Outer Pull" Configuration.

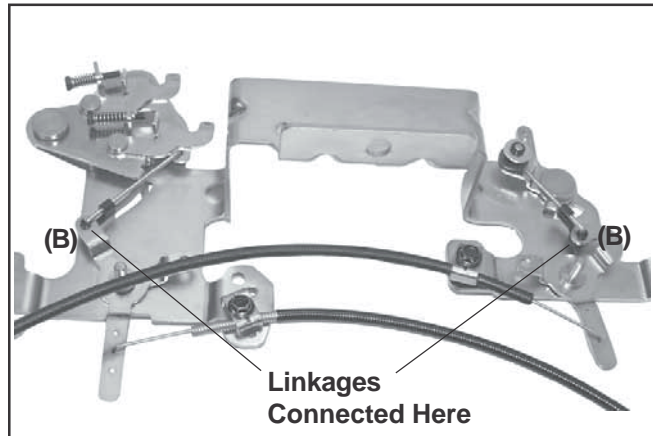

Figure 6. Throttle and Choke Control Linkage in "Inner Pull" Configuration.



### **WARNING: Lethal Exhaust Gases!**

Engine exhaust gases contain poisonous carbon monoxide. Carbon monoxide is odorless, colorless, and can cause death if inhaled. Avoid inhaling exhaust fumes, and never run the engine in a closed building or confined area.

### Cold Weather Starting Hints

1. Be sure to use the proper oil for the temperature expected. See Figure 2 on page 4.
2. Disengage all possible external loads.
3. Be sure the battery is in good condition. A warm battery has much more starting capacity than a cold battery.
4. Use fresh winter grade fuel. NOTE: Winter grade gasoline has higher volatility to improve starting. Do not use gasoline left over from summer.

### Starting

1. Place the throttle control **midway** between the **slow** and **fast** positions. Place the choke control into the **on** position. See Figures 7 and 8.

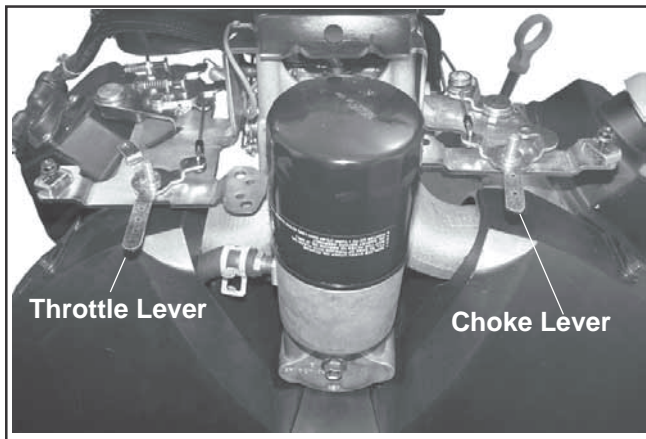

**Figure 7. Location of Control Levers.**

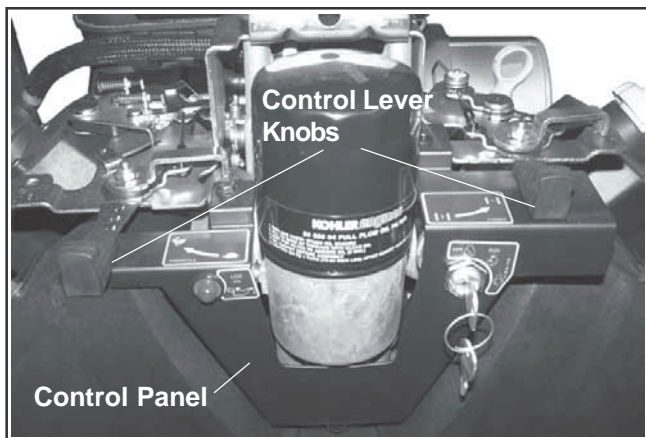

**Figure 8. Optional Control Panel with Engine Mounted Controls.**

2. Start the engine by activating the key switch. Release the switch as soon as the engine starts.

**NOTE:** Do not crank the engine continuously for more than 10 seconds at a time. If the engine does not start, allow a 60 second cool down period between starting attempts. Failure to follow these guidelines can burn out, or permanently damage, the starter motor.

**NOTE:** Upon start-up, a metallic ticking may occur. This is caused by hydraulic lifter leakdown during storage. Run the engine for 5 minutes. The noise will normally cease in the first minute. If noise continues, run the engine at mid-throttle for 20 minutes. If noise persists, take the engine to your local authorized Kohler Engine Service Dealer.

**NOTE:** If the engine develops sufficient speed to disengage the starter but does not keep running (a false start), engine rotation must be allowed to come to a complete stop before attempting to restart the engine. If the starter is engaged while the flywheel is rotating, the starter pinion and flywheel ring gear may clash resulting in damage to the starter.

If the starter does not turn the engine over, shut off starter immediately. Do not make further attempts to start the engine until the condition is corrected. Do not jump start using another battery (refer to **Battery** on this page). See your Kohler Engine Service Dealer for service assistance.

3. **For a Cold Engine** – Gradually return the choke control to the **off** position after the engine starts and warms up.

The engine/equipment may be operated during the warm-up period, but it may be necessary to leave the choke partially on until the engine warms up.

4. **For a Warm Engine** – Return choke to **off** position as soon as engine starts.

### Stopping

1. Remove the load by disengaging all PTO driven attachments.
2. Position the throttle control somewhere between half and full throttle; then stop the engine.

### Battery

A 12 volt battery is normally used. Refer to the operating instructions of the equipment this engine powers for specific battery requirements.

If the battery charge is not sufficient to crank the engine, recharge the battery (see page 13).

### Operating

#### Angle of Operation

This engine will operate continuously at angles up to 25°. Check oil level to assure crankcase oil level is at the "F" mark on the dipstick.

Refer to the operating instructions of the equipment this engine powers. Because of equipment design or application, there may be more stringent restrictions regarding the angle of operation.

**NOTE:** Do not operate this engine continuously at angles exceeding 25° in any direction. Engine damage could result from insufficient lubrication.

#### Cooling

**NOTE:** If debris builds up on the grass screen or other cooling air intake areas, stop the engine immediately and clean. Operating the engine with blocked or dirty air intake and cooling areas can cause extensive damage due to overheating.

**WARNING: Hot Parts!**

Engine components can get extremely hot from operation. To prevent severe burns, do not touch these areas while the engine is running, or immediately after it is turned off. Never operate the engine with heat shields or guards removed.

**Engine Speed**

**NOTE:** Do not tamper with the governor setting to increase the maximum engine speed. Overspeed is hazardous and will void the engine warranty. The maximum allowable high idle speed for these engines is 3900 RPM, no load.

**Maintenance Instructions**

Maintenance, repair, or replacement of the emission control devices and systems, which are being done at the customers expense, may be performed by any non-road engine repair establishment or individual. Warranty repairs must be performed by an authorized Kohler service outlet.

**WARNING: Accidental Starts!**

Disabling engine. Accidental starting can cause severe injury or death. Before working on the engine or equipment, disable the engine as follows: 1) Disconnect the spark plug lead(s). 2) Disconnect negative (-) battery cable from battery.

**Maintenance Schedule**

These required maintenance procedures should be performed at the frequency stated in the table. They should also be included as part of any seasonal tune-up.

| Frequency                       | Maintenance   |
|---------------------------------|---|
| Daily or Before Starting Engine | <ul style="list-style-type: none"> <li>• Fill fuel tank.</li> <li>• Check oil level.</li> <li>• Check air cleaner for dirty<sup>1</sup>, loose, or damaged parts.</li> <li>• Check air intake and cooling areas, clean as necessary.</li> </ul>   |
| Weekly                          | <ul style="list-style-type: none"> <li>• Check filter minder or air cleaner element.</li> </ul>   |
| Seasonally or Every 150 Hours   | <ul style="list-style-type: none"> <li>• Check air cleaner element.</li> <li>• Replace fuel filter</li> <li>• Change oil. Oil filter is recommended. (More frequently under severe conditions.)</li> <li>• Remove cooling shrouds and clean cooling areas<sup>1</sup>.</li> <li>• Check oil cooler fins, clean as necessary.</li> </ul> |
| Every 200 Hours                 | <ul style="list-style-type: none"> <li>• Check spark plug condition and gap.</li> </ul>   |
| Seasonally or Every 300 Hours   | <ul style="list-style-type: none"> <li>• Change oil filter</li> <li>• Replace air cleaner element.</li> </ul>   |
| Yearly or Every 500 Hours       | <ul style="list-style-type: none"> <li>• Have solenoid shift starter disassembled and cleaned.</li> <li>• Have crankshaft splines lubricated<sup>2</sup>.</li> </ul>  |
| Every 600 Hours                 | <ul style="list-style-type: none"> <li>• Replace inner air cleaner element.</li> <li>• Replace spark plugs.</li> </ul>  |

<sup>1</sup>Perform these maintenance procedures more frequently under extremely dusty, dirty conditions.

<sup>2</sup>Have a Kohler Engine Service Dealer perform this service.

**Check Oil Level**

The importance of checking and maintaining the proper oil level in the crankcase cannot be overemphasized. Check oil **BEFORE EACH USE** as follows:

1. Make sure the engine is stopped, level, and is cool so the oil has had time to drain into the sump.
2. To keep dirt, debris, etc., out of the engine, clean the area around the dipstick before removing it.
3. Remove the dipstick; wipe oil off. Reinsert the dipstick into the tube and press all the way down.



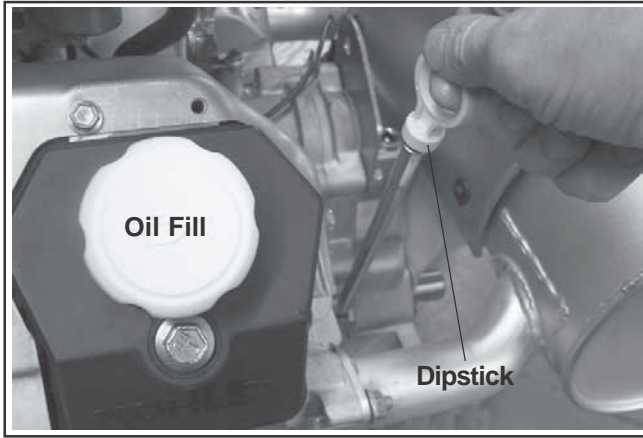

Figure 9. Dipstick and Oil Fill.

- Remove the dipstick and check the oil level. The oil level should be up to, but not over, the "F" mark on the dipstick. See Figure 10.

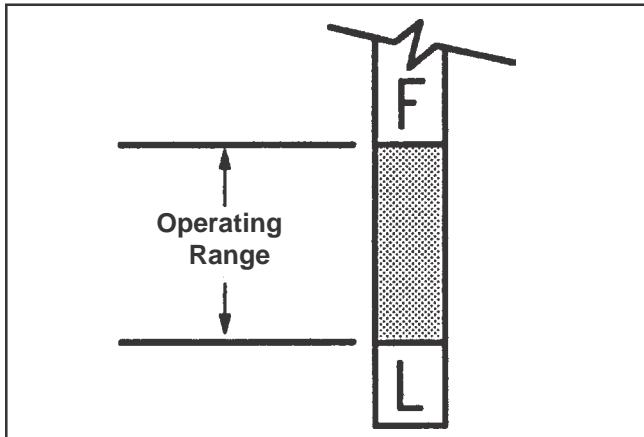

Figure 10. Oil Level Marks on Dipstick.

- If the level is low, remove the cap from the valve cover and add oil of the proper type, up to the "F" mark on the dipstick. (Refer to **Oil Type** on page 4.) Always check the level with the dipstick before adding more oil.

NOTE: To prevent extensive engine wear or damage, always maintain the proper oil level in the crankcase. Never operate the engine with the oil level below the "L" mark or over the "F" mark on the dipstick.

### Oil Sentry™

Most engines are equipped with an Oil Sentry™ oil pressure switch. On pressure switch equipped models, if the oil pressure decreases below an acceptable level, the Oil Sentry™ will either shut off the engine or activate a warning signal, depending on the application. See Figure 11.

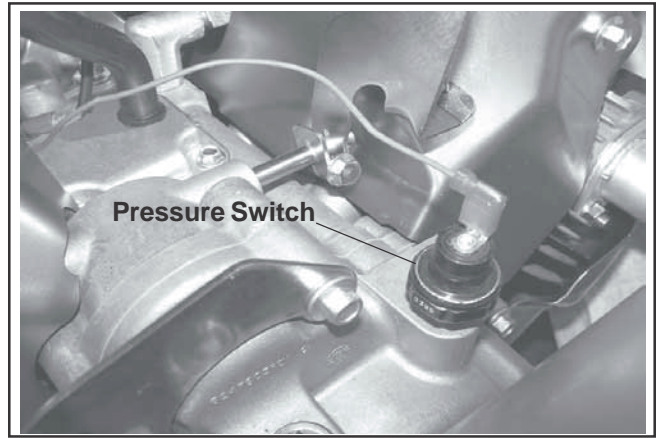

Figure 11. Oil Sentry™ Pressure Switch.

NOTE: Make sure the oil level is checked **BEFORE EACH USE** and is maintained up to the "F" mark on the dipstick. This includes engines equipped with Oil Sentry™ systems.

## Change Oil and Filter, Service Oil Cooler

### Change Oil

Change oil **seasonally or every 150 hours** of operation, (more frequently under severe conditions). Refill with service class SG, SH, SJ or higher oil as specified in the **Viscosity Grades** table (Figure 2) on page 4.

Change the oil while the engine is still warm. The oil will flow more freely and carry away more impurities. Make sure the engine is level when filling, checking, and changing the oil.

Change the oil as follows (see Figures 12 and 13):

- To keep dirt, debris, etc., out of the engine, clean the area around the oil fill cap, dipstick and one of the drain plugs.
- Remove one of the oil drain plugs, oil fill cap, and dipstick. Be sure to allow ample time for complete drainage.
- Reinstall the drain plug. Make sure it is tightened to **21.4 N·m (15.7 ft. lb.)** torque.
- Fill the crankcase, with new oil of the proper type, to the "F" mark on the dipstick. Refer to Oil Type on page 4. Always check the level with the dipstick before adding more oil.
- Reinstall the oil fill cap and tighten securely. Reinstall dipstick.

**NOTE:** To prevent extensive engine wear or damage, always maintain the proper oil level in the crankcase. Never operate the engine with the oil level below the “L” mark or over the “F” mark on the dipstick.

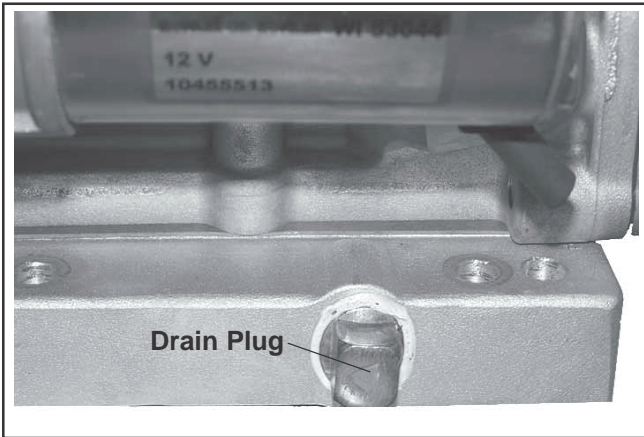

**Figure 12. Oil Drain Plug (Starter Side).**

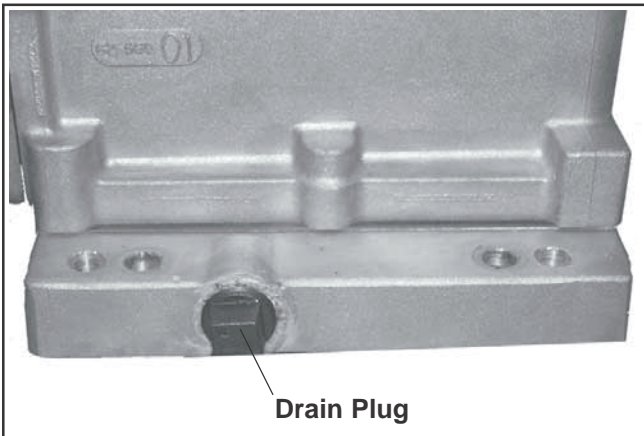

**Figure 13. Oil Drain Plug (No. 2 Side).**

### Change Oil Filter

The oil filter on most engines is located on top of the crankcase between the cylinders. Some models use a remote mounted oil filter. See Figures 14 and 15. Replace the oil filter **seasonally (150 hours), or at least every other oil change (every 300 hours of operation)**. *Always use a genuine Kohler oil filter, Part No. 52 050 02-S.*

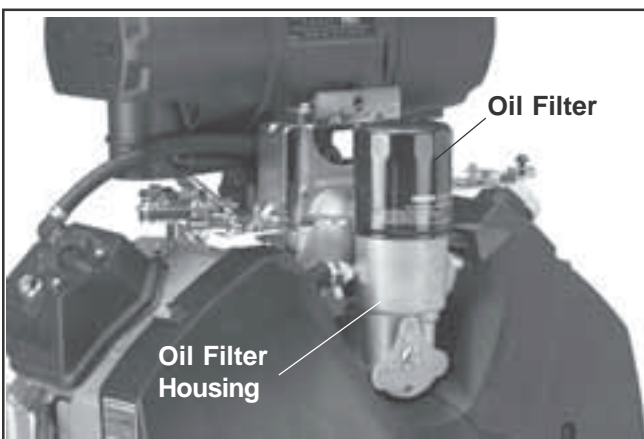

**Figure 14. Engine Mounted Oil Filter.**



**Figure 15. Optional Remote Mounted Oil Filter.**

Replace the oil filter as follows:

1. Before removing the oil filter, clean the area around the oil filter and housing to keep dirt and debris out of the engine. Remove the old filter. On crankcase mounted oil filter housings, a spring loaded inner cup allows automatic oil drainback into the crankcase as the oil filter is removed. Wipe off the surface where the oil filter mounts.
2. Drain the oil from the engine crankcase.
3. Allow ample time for the oil to drain from the crankcase.
4. Reinstall the drain plug and torque to **21.4 N·m (15.7 ft. lb.)**.
5. Apply a thin film of clean oil to the rubber gasket on the new filter.
6. Install the replacement oil filter. Turn the oil filter clockwise until the rubber gasket contacts the oil filter housing (not inner cup), then tighten the filter an additional **3/4 to 1 turn**.
7. Fill the crankcase with new oil of the proper type to the “F” mark on the dipstick.
8. Start the engine and check for oil leaks. Correct any leaks before placing the engine into service. Check oil level to be sure it is up to but not over the “F” mark.

### Service Oil Cooler

Engines are equipped with an oil cooler mounted under the No. 2 side cylinder shroud, separate from the oil filter (see Figure 16).

Inspect and clean the oil cooler **every 150 hours of operation** (more frequently under severe conditions). Oil cooler must be kept free of debris.

To access and service the oil cooler, remove the top mounting screw and loosen the two side screws, then lift off the No. 2 side cylinder shroud. If required remove the two screws holding the oil cooler to the blower housing. Pull the cooler away from the blower housing. Clean both sides of the cooler with a brush as shown in Figures 17 and 18, or with compressed air. After cleaning, reattach the oil cooler to the lower blower housing with the two mounting screws.

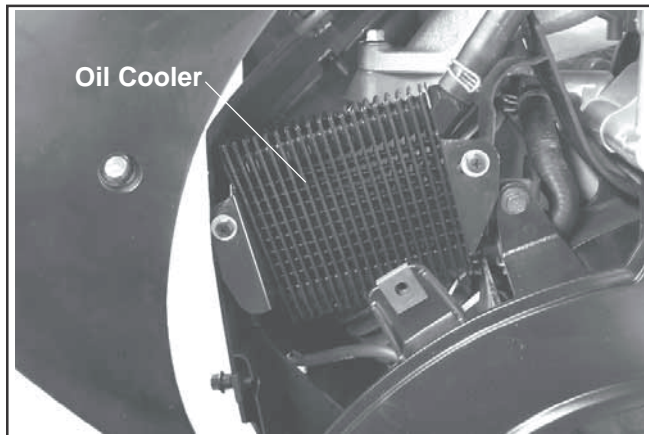

Figure 16. Oil Cooler.

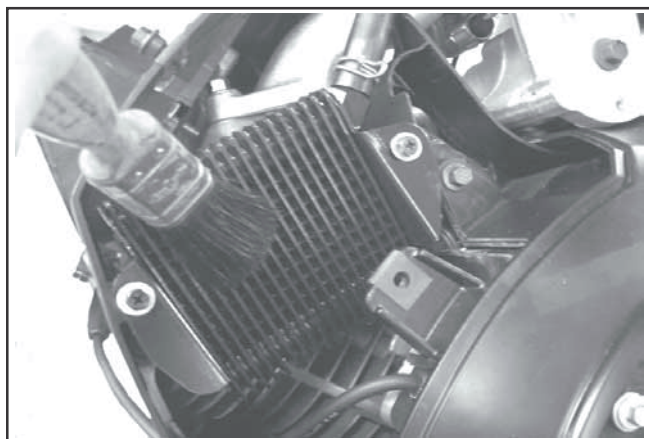

Figure 17. Cleaning Top of Oil Cooler.



Figure 18. Cleaning Underside of Oil Cooler.

## Air Cleaners

### General

These engines use a heavy-duty style air cleaner shown in Figure 19, consisting of a cylindrical housing mounted to the carburetor and intake manifold. The air cleaner housing contains a paper element and inner element, designed for longer service intervals. The system is CARB/EPA certified and the components should not be altered or modified in any way.

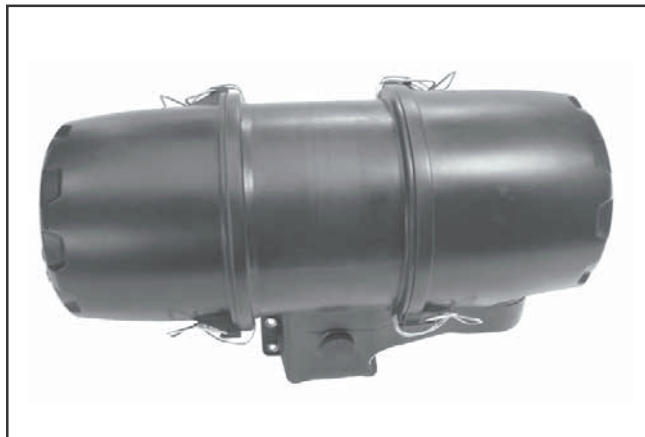

Figure 19. Heavy-Duty Style Air Cleaner.

### Service

**Weekly and every 150 hours:** Check filter minder (if equipped), unhook the two retaining clips on each end and remove the end caps. Perform inspection of the paper element and inlet screen area.

**Seasonally or every 300 hours** of operation (more often under extremely dusty or dirty conditions), replace the paper element and check the inner element. Follow these steps.

1. Unhook the two retaining clips on each end and remove the end caps from the air cleaner housing.
2. Check and clean the screen area on the inlet side. Pull the air cleaner paper element out of the housing on opposite side. See Figures 20 and 21.

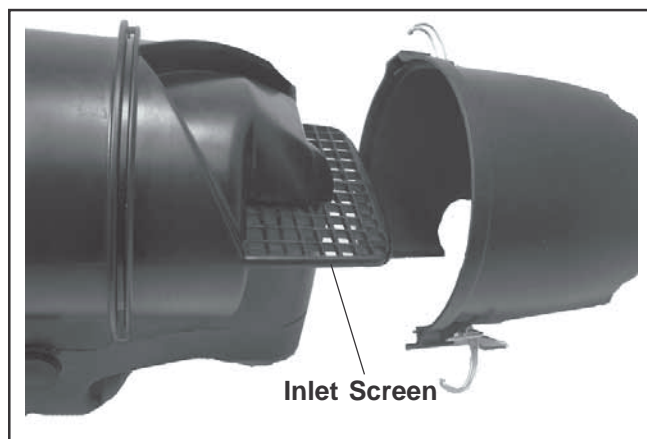
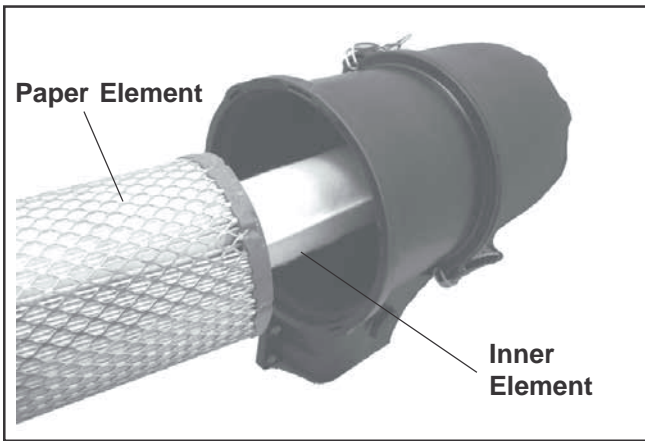
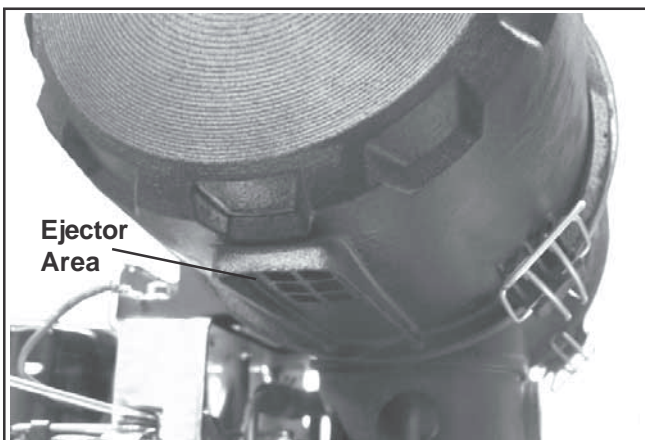

Figure 20. Accessing Inlet Screen.



**Figure 21. Removing Elements.**

3. After the paper element is removed, check the condition of the inner element. It should be replaced whenever it appears dirty, typically every other time the paper element is replaced or every **600 hours**. Clean the area around the base of the inner element before removing it, so dirt does not get into the engine.
4. **Do not** wash the paper element and inner element or use compressed air, this will damage the elements. Replace dirty, bent or damaged elements with new genuine Kohler elements as required. Handle the new elements carefully; do not use if the sealing surfaces are bent or damaged.
5. Check all parts for wear, cracks, or damage, and make sure ejector area is clean. See Figure 22. Replace any damaged components.



**Figure 22. Ejector Area.**

6. Install the new inner element, Kohler Part No. **25 083 04-S** followed by the paper element, Part No. **25 083 01-S**. Slide each fully into place in the air cleaner housing.
7. Reinstall the end caps and secure with the retaining clips. See Figure 19.

## Clean Air Intake/Cooling Areas

To ensure proper cooling, make sure the grass screen, cooling fins, and other external surfaces of the engine are kept clean **at all times**.

**NOTE:** Operating the engine with a blocked grass screen, dirty or plugged cooling fins, and/or cooling shrouds removed, will cause engine damage due to overheating.

## Ignition System

An electronic Capacitive Discharge (CD) ignition system is used. Other than periodically checking/replacing the spark plugs, no maintenance, timing, or adjustments are necessary or possible with this system.

## Check Spark Plugs

Every **200 hours** of operation, remove the spark plugs, check condition, and reset the gap. Replace with new plugs every **600 hours**, or as necessary. The standard spark plug is a Champion® XC10YC (Kohler Part No. 62 132 04-S). Equivalent alternate brand plugs can also be used.

1. Before removing the spark plug, clean the area around the base of the plug to keep dirt and debris out of the engine.
2. Remove the plug and check its condition. Replace the plug if worn or reuse is questionable.

**NOTE:** Do not clean the spark plug in a machine using abrasive grit. Some grit could remain in the spark plug and enter the engine causing extensive wear and damage.

3. Check the gap using a wire feeler gauge. Adjust the gap to **0.76 mm (0.030 in.)** by carefully bending the ground electrode. See Figure 23.

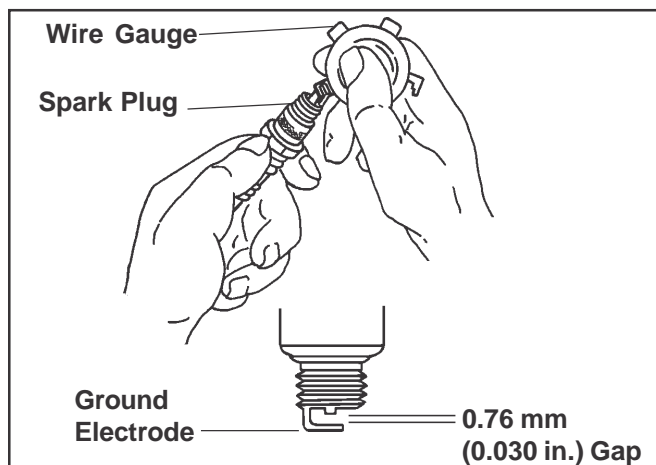

**Figure 23. Servicing Spark Plug.**

- Reinstall the spark plug into the cylinder head.  
Torque the spark plug to **24.4-29.8 N·m**  
(18-22 ft. lb.).

## Battery Charging



### **WARNING: Explosive Gas!**

Batteries produce explosive hydrogen gas while being charged. To prevent a fire or explosion, charge batteries only in well ventilated areas. Keep sparks, open flames, and other sources of ignition away from the battery at all times. Keep batteries out of the reach of children. Remove all jewelry when servicing batteries.

Before disconnecting the negative (-) ground cable, make sure all switches are OFF. If ON, a spark will occur at the ground cable terminal which could cause an explosion if hydrogen gas or gasoline vapors are present.

NOTE: Do not apply 12 volt DC to kill terminal of ignition module.

## Fuel System

### Fuel Filter

Most engines are equipped with an in-line fuel filter. Periodically inspect the filter and replace with a genuine Kohler filter **seasonally or every 150 operating hours**.

### Fuel Line

These engines use Low Permeation SAE 30 R7 rated fuel line; certified to meet emission requirements. Standard fuel line may not be used. Order replacement hose by part number through a Kohler Engine Service Dealer.

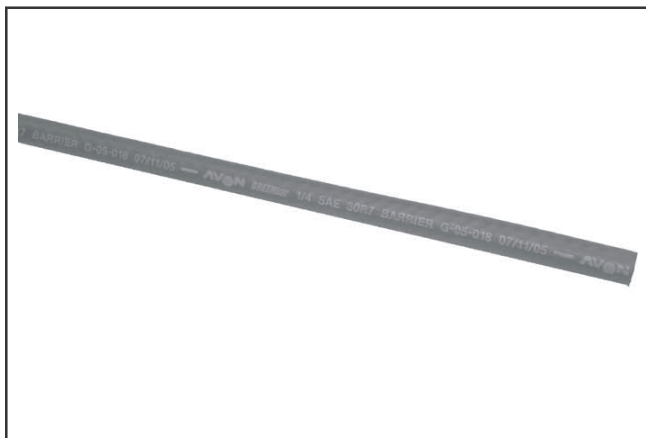

Figure 24. Low Permeation Fuel Line.

## Carburetor Troubleshooting and Adjustments

These engines use a Keihin BK two-barrel carburetor with fixed main jets, and fixed or limiter-equipped low idle fuel adjusting needles. See Figure 25. In compliance with government emission standards, the carburetor is calibrated to deliver the correct fuel-to-air mixture to the engine under all operating conditions. Adjustments are made as follows.

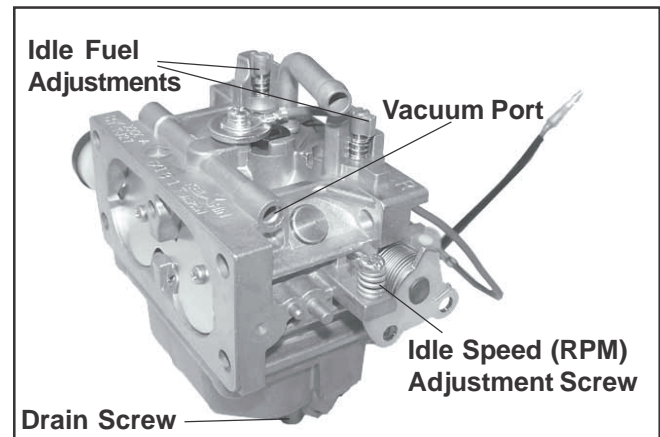

Figure 25. Keihin Two-Barrel Carburetor.

NOTE: Carburetor adjustments should be made only after the engine has warmed up.

NOTE: To ensure correct engine operation at altitudes above 1525 meters (5000 ft.), it may be necessary to have an authorized Kohler dealer install a special high-altitude jet kit in the carburetor. If a high-altitude kit has been installed, the engine must be reconverted to the original jet size, before it is operated at lower altitudes, or overheating and engine damage can result.

### Troubleshooting

If engine troubles are experienced that appear to be fuel system related, check the following areas before adjusting the carburetor.

- Make sure the fuel tank is filled with clean, fresh gasoline.
- Make sure the fuel tank cap vent is not blocked and that it is operating properly.
- If the fuel tank is equipped with a shut-off valve, make sure it is open.
- If the engine is equipped with an in-line fuel filter, make sure it is clean and unobstructed. Replace the filter if necessary.

- Make sure fuel is reaching the carburetor. This includes checking the fuel lines and fuel pump for restrictions or faulty components, replace as necessary.
- Make sure the air cleaner element is clean and all air cleaner element components are fastened securely.

If, after checking the items listed above, the engine is hard to start, runs roughly, or stalls at low idle speed, it may be necessary to adjust or service the carburetor.

### Adjust Carburetor

#### Low Idle Speed (RPM) and Governed Idle Adjustment

1. **Low Idle Speed (RPM) Setting:** Place the throttle control into the **idle** or **slow** position. Hold the governor lever away from carburetor so the throttle lever is against the Idle Speed (RPM) Adjustment Screw of carburetor. See Figure 25. Set the low idle speed to **1200 RPM\*** ( $\pm 75$  RPM) by turning the low idle speed adjusting screw on carburetor **in or out**. Check the speed using a tachometer.

\*NOTE: The actual low idle speed depends on the application. Refer to the equipment manufacturer's recommendations. The low idle speed for basic engines is 1200 RPM. To ensure best results when setting the low idle fuel needle, the low idle speed should be 1200 RPM ( $\pm 75$  RPM).

2. Release the governor lever and check that the throttle lever is in the **idle** position. Turn the governed idle (outer) adjustment screw on main control bracket to obtain the equipment manufacturer's recommended idle speed (1400-1800 RPM). See Figure 26.

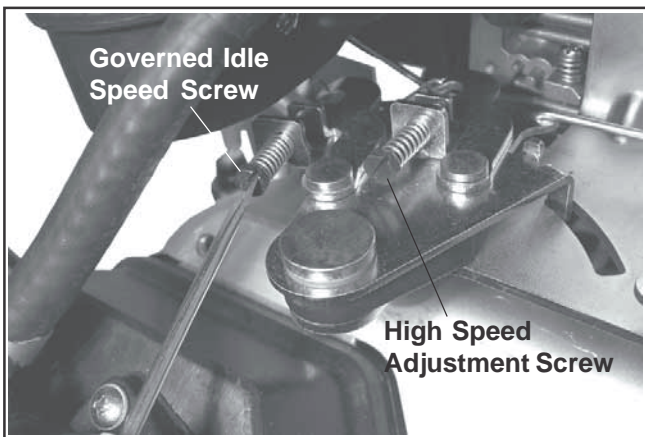

Figure 26. Adjusting Governed Idle Speed Screw.

#### Low Idle Fuel Adjustment

NOTE: Engines will have fixed low idle or limiter caps on the two idle fuel adjusting needles. Step 3 can only be performed within the limits allowed by the cap. Do not attempt to remove the limiter caps.

1. Start the engine and run at half throttle for 5 to 10 minutes to warm up. The engine must be warm before doing steps 2, 3 and 4.
2. Place the throttle control into the **idle** or **slow** position. Adjust the low idle speed to **1200 RPM\***.

Follow the **Adjusting the Low Idle Speed (RPM)** procedure.

3. **Low Idle Fuel Needle(s) Setting:** Place the throttle into the **idle** or **slow** position.
  - a. Turn one of the low idle fuel adjusting needles out (counterclockwise) from the preliminary setting until the engine speed decreases (rich). Note the position of the needle. Now turn the adjusting needle in (clockwise). The engine speed may increase, then it will decrease as the needle is turned **in** (lean). Note the position of the needle. Set the adjusting needle midway between the rich and lean settings. See Figure 27.
  - b. Repeat the procedure on the other low idle adjustment needle.
4. Recheck/adjust the **Low Idle Speed (RPM)**, to the specified setting.

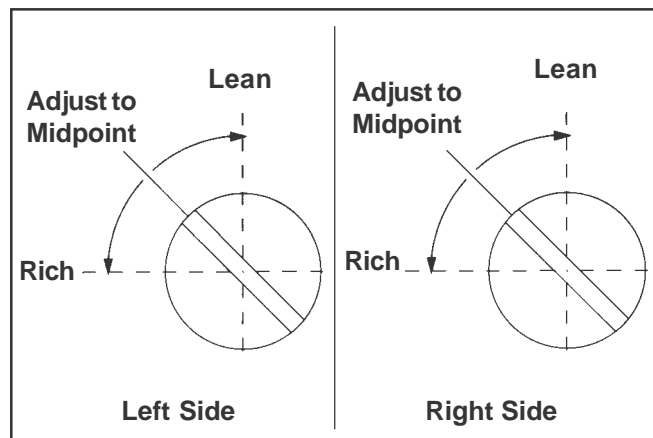

Figure 27. Optimum Low Idle Fuel Settings.

#### High Speed (RPM) Adjustment

The high speed RPM (inner) adjustment screw is preset at the factory and normally does not need readjustment.

## Troubleshooting

When troubles occur, be sure to check the simple causes which, at first, may seem too obvious to be considered. For example, a starting problem could be caused by an empty fuel tank. Some common causes of engine troubles are listed in the following table.

Do not attempt to service or replace major engine components, or any items that require special timing or adjustment procedures. Have your Kohler Engine Service Dealer do this work.

| Possible Cause Problem | No Fuel | Improper Fuel | Dirt In Fuel Line/System | Dirty Grass Screen | Incorrect Oil Level | Engine Overloaded | Dirty Air Cleaner | Faulty Spark Plug |
|------------------------|---------|---------------|--------------------------|--------------------|---------------------|-------------------|-------------------|-------------------|
| Will Not Start         | •       | •             | •                        |                    | •                   | •                 | •                 | •                 |
| Hard Starting          |         | •             | •                        |                    |                     | •                 | •                 | •                 |
| Stops Suddenly         | •       |               | •                        | •                  | •                   | •                 | •                 | •                 |
| Lacks Power            |         | •             | •                        | •                  | •                   | •                 | •                 | •                 |
| Operates Erratically   |         | •             | •                        | •                  |                     | •                 | •                 | •                 |
| Knocks or Pings        |         | •             |                          | •                  |                     | •                 |                   | •                 |
| Skips or Misfires      |         | •             | •                        | •                  |                     |                   | •                 | •                 |
| Backfires              |         | •             | •                        |                    |                     | •                 | •                 | •                 |
| Overheats              |         | •             | •                        | •                  | •                   | •                 | •                 |                   |
| High Fuel Consumption  |         |               |                          |                    |                     | •                 | •                 | •                 |

## Storage

If the engine will be out of service for 30 days or more, use the following storage procedure:

1. Clean the exterior surfaces of the engine. Avoid spraying water at the wiring harness or any of the electrical components.
2. Change the oil and filter while the engine is still warm from operation. See **Change Oil** and **Change Oil Filter** on pages 9 and 10.
3. The fuel system must be completely emptied, or the gasoline must be treated with a stabilizer to prevent deterioration. If you choose to use a stabilizer, follow the manufacturer's recommendations, and add the correct amount for the capacity of the fuel system. Fill the fuel tank with clean, fresh gasoline. Run the engine for 2-3 minutes to get stabilized fuel into the rest of the system. Close fuel shut-off valve when unit is being stored or transported.

To empty the system, run the engine until the tank and fuel system are empty.

4. Remove the spark plugs. Add one tablespoon of engine oil into each spark plug hole. Install the plugs, but do not connect the plug leads. Crank the engine two or three revolutions.
5. Store the engine in a clean, dry place.

## Parts Ordering

The engine Specification, Model, and Serial Numbers are required when ordering replacement parts from your Kohler Engine Service Dealer. These numbers are found on the identification plate which is affixed to the engine shrouding. Include letter suffixes if there are any. See **Engine Identification Numbers** on page 5.

*Always insist on genuine Kohler parts.* All genuine Kohler parts meet strict standards for fit, reliability, and performance.

## Major Repair

Major repair information is available in Kohler Engine Service Manuals. This type of repair generally requires the services of a trained mechanic and the use of special tools and equipment. Kohler Engine Service Dealers have the facilities, training, and genuine Kohler replacement parts necessary to perform this service.

For the nearest Sales & Service location:

- visit our website [www.kohlerengines.com](http://www.kohlerengines.com)
- call 1-800-544-2444 (U.S. & Canada)
- look in the business listing under Engines-Gasoline

## Specifications

|  |                                  |                   |                   |
|--|----------------------------------|-------------------|-------------------|
| Model:   | CH940                            | CH960             | CH980             |
| Bore:  | 90 (3.54)                        | 90 (3.54)         | 90 (3.54)         |
| Stroke:  | 78.5 (3.1)                       | 78.5 (3.1)        | 78.5 (3.1)        |
| Displacement:  | 999 (61)                         | 999 (61)          | 999 (61)          |
| Power (@3600 RPM):   | 25.4 (34*)                       | 26.9 (36*)        | 28.3 (38*)        |
| Max. Peak Torque (@ RPM):  | 74.0 (54.6) @2800                | 74.9 (55.3) @2800 | 75.6 (55.8) @2800 |
| Compression Ratio:   | 8.8:1                            | 8.8:1             | 8.8:1             |
| Weight:  | 59.8 (132)                       | 59.8 (132)        | 59.8 (132)        |
| Oil Capacity (w/filter) - approximate,<br>determined by oil filter used: | 2.7 L (2.9 U.S. qt.)             |                   |                   |
| Lubrication:   | Full Pressure w/full Flow Filter |                   |                   |

Exhaust Emission Control System for models CH940-980 is EM.

\*Horsepower ratings exceed Society of Automotive Engineers Small Engine Test Code J1940. Actual engine horsepower is lower and affected by, but not limited to, accessories (air cleaner, exhaust, charging, cooling, fuel pump, etc.), application, engine speed and ambient operating conditions (temperature, humidity, and altitude). Kohler reserves the right to change product specifications, designs and equipment without notice and without incurring obligation.

### LIMITED 2 YEAR COMMAND PRO ENGINE WARRANTY

Kohler Co. warrants to the original consumer that each new COMMAND PRO engine sold by Kohler Co. will be free from manufacturing defects in materials or workmanship in normal service for a period of two (2) years from date of purchase, provided it is operated and maintained in accordance with Kohler Co.'s instructions and manuals.

Our obligation under this warranty is expressly limited, at our option, to the replacement or repair at Kohler Co., Kohler, Wisconsin 53044, or at a service facility designated by us of such parts as inspection shall disclose to have been defective.

#### EXCLUSIONS

Mufflers on engines used commercially (non-residential) are warranted for one (1) year from date of purchase, except catalytic mufflers, which are warranted for two (2) years.

This warranty does not apply to defects caused by casualty or unreasonable use, including faulty repairs by others and failure to provide reasonable and necessary maintenance.

The following items are not covered by this warranty:

Engine accessories such as fuel tanks, clutches, transmissions, power-drive assemblies, and batteries, unless supplied or installed by Kohler Co. These are subject to the warranties, if any, of their manufacturers.

KOHLER CO. AND/OR THE SELLER SHALL NOT BE LIABLE FOR SPECIAL, INDIRECT, INCIDENTAL, OR CONSEQUENTIAL DAMAGES OF ANY KIND, including but not limited to labor costs or transportation charges in connection with the repair or replacement of defective parts.

IMPLIED OR STATUTORY WARRANTIES, INCLUDING WARRANTIES OF MERCHANTABILITY OR FITNESS FOR A PARTICULAR PURPOSE, ARE EXPRESSLY LIMITED TO THE DURATION OF THIS WRITTEN WARRANTY. We make no other express warranty, nor is any one authorized to make any on our behalf.

Some states do not allow limitations on how long an implied warranty lasts, or the exclusion or limitation of incidental or consequential damages, so the above limitation or exclusion may not apply to you.

This warranty gives you specific legal rights, and you may also have other rights which vary from state to state.

#### TO OBTAIN WARRANTY SERVICE

Purchaser must bring the engine to an authorized Kohler service facility. To locate the nearest facility, visit our website, [www.kohlerengines.com](http://www.kohlerengines.com), and click on SALES AND SERVICES to use the locator function, consult your Yellow Pages or telephone 1-800-544-2444.

ENGINE DIVISION, KOHLER CO., KOHLER, WISCONSIN 53044



**KOHLER CO.**  
**FEDERAL AND CALIFORNIA EMISSION CONTROL SYSTEMS**  
**LIMITED WARRANTY**  
**SMALL OFF-ROAD AND CLASS 1 LSI ENGINES**

The U.S. Environmental Protection Agency (EPA), the California Air Resources Board (CARB), and Kohler Co. are pleased to explain the Federal and California Emission Control Systems Warranty on your off-road equipment engine. For California, small off-road engines produced in 1995 and later, and Class 1 LSI (Large Spark Ignited engines at or below 1.0 liter) produced in 2002 and later, must be designed, built and equipped to meet the state's stringent anti-smog standards. In other states, 1997 and later model year engines must be designed, built and equipped, to meet the U.S. EPA regulations for small non-road engines. The engine must be free from defects in materials and workmanship, which cause it to fail to conform with U.S. EPA standards for the first two years of engine use from the date of sale to the ultimate purchaser. Kohler Co. must warrant the emission control system on the engine for the period of time listed above, provided there has been no abuse, neglect or improper maintenance.

The emission control system may include parts such as the carburetor or fuel injection system, the ignition system, and catalytic converter. Also included are the hoses, belts and connectors and other emission-related assemblies.

Where a warrantable condition exists, Kohler Co. will repair the engine at no cost, including diagnosis (if the diagnostic work is performed at an authorized dealer), parts and labor.

**MANUFACTURER'S WARRANTY COVERAGE**

Small off-road engines produced in 1995 or later, and Class 1 LSI engines produced in 2002 and later, are warranted for two years in California. In other states, 1997 and later model year engines are warranted for two years. If any emission related part on the engine is defective, the part will be repaired or replaced by Kohler Co. free of charge.

**OWNER'S WARRANTY RESPONSIBILITIES**

- (a) The engine owner is responsible for the performance of the required maintenance listed in the owner's manual. Kohler Co. recommends that you retain all receipts covering maintenance on the engine, but Kohler Co. cannot deny warranty solely for the lack of receipts or for your failure to assure that all scheduled maintenance was performed.
- (b) Be aware, however, that Kohler Co. may deny warranty coverage if the engine or a part has failed due to abuse, neglect, improper maintenance or unapproved modifications.
- (c) For warranty repairs, the engine must be presented to a Kohler Co. service center as soon as a problem exists. Call 1-800-544-2444 or access our website at: [www.kohlerengines.com](http://www.kohlerengines.com), for the names of the nearest service centers. The warranty repairs should be completed in a reasonable amount of time, not to exceed 30 days.

If you have any questions regarding warranty rights and responsibilities, you should contact Kohler Co. at 1-920-457-4441 and ask for an Engine Service representative.

**COVERAGE**

Kohler Co. warrants to the ultimate purchaser and each subsequent purchaser that the engine will be designed, built and equipped, at the time of sale, to meet all applicable regulations. Kohler Co. also warrants to the initial purchaser and each subsequent purchaser, that the engine is free from defects in materials and workmanship which cause the engine to fail to conform with applicable regulations for a period of two years.

Small off-road engines produced in 1995 or later, and Class 1 LSI engines produced in 2002 and later, are warranted for two years in California. For 1997 and later model years, EPA requires manufacturers to warrant engines for two years in all other states. These warranty periods will begin on the date the engine is purchased by the initial purchaser. If any emission related part on the engine is defective, Kohler Co. will replace the part at no cost to the owner. Kohler Co. is liable for damages to other engine components caused by the failure of a warranted part still under warranty.

Kohler Co. shall remedy warranty defects at any authorized Kohler Co. engine dealer or warranty station. Warranty repair work done at an authorized dealer or warranty station shall be free of charge to the owner if such work determines that a warranted part is defective.

Listed below are the parts covered by the Federal and California Emission Control Systems Warranty. Some parts listed below may require scheduled maintenance and are warranted up to the first scheduled replacement point for that part. The warranted parts are:

- Carburetor assembly
- Throttle body (EFI Systems)
- Catalytic muffler (if equipped)
- Fuel metering valve (if equipped)
- Crankcase breather
- Fuel pressure regulator (EFI Systems)
- Ignition module(s) with high tension lead
- Spark advance module (if equipped)
- Oxygen, speed, throttle position, and temperature sensors (if equipped)
- Electronic control unit (if equipped)
- Fuel injectors (EFI Systems)
- Air filter, fuel filter, and spark plugs (only to first scheduled replacement point)

Continued on next page.

---

### LIMITATIONS

This Emission Control Systems Warranty shall not cover any of the following:

- (a) repair or replacement required because of misuse or neglect, improper maintenance, repairs improperly performed or replacements not conforming to Kohler Co. specifications that adversely affect performance and/or durability and alterations or modifications not recommended or approved in writing by Kohler Co.,
- (b) replacement of parts and other services and adjustments necessary for required maintenance at and after the first scheduled replacement point,
- (c) consequential damages such as loss of time, inconvenience, loss of use of the engine or equipment, etc.,
- (d) diagnosis and inspection fees that do not result in eligible warranty service being performed, and
- (e) any add-on or modified part, or malfunction of authorized parts due to the use of add-on or modified parts.

### MAINTENANCE AND REPAIR REQUIREMENTS

The owner is responsible for the proper use and maintenance of the engine. Kohler Co. recommends that all receipts and records covering the performance of regular maintenance be retained in case questions arise. If the engine is resold during the warranty period, the maintenance records should be transferred to each subsequent owner. Kohler Co. reserves the right to deny warranty coverage if the engine has not been properly maintained; however, Kohler Co. may not deny warranty repairs solely because of the lack of repair maintenance or failure to keep maintenance records.

Normal maintenance, replacement or repair of emission control devices and systems may be performed by any repair establishment or individual; however, **warranty repairs must be performed by a Kohler authorized service center**. Any replacement part or service that is equivalent in performance and durability may be used in non-warranty maintenance or repairs, and shall not reduce the warranty obligations of the engine manufacturer.



# KOHLER<sup>®</sup> ENGINES

FOR SALES AND SERVICE INFORMATION  
IN U.S. AND CANADA, CALL **1-800-544-2444**

[KohlerEngines.com](http://KohlerEngines.com)

ENGINE DIVISION, KOHLER CO., KOHLER, WISCONSIN 53044

|           |           |
|-----------|-----------|
| FORM NO.: | 62 590 01 |
| ISSUED:   | 1/07      |
| REVISED:  |           |
| MAILED:   |           |

LITHO IN U.S.A.



1P62 590 01



6 50531 53714 0