

TWIN HEAD HORIZONTAL BANDRESAW



- The operator must thoroughly read this manual before operation.
- Keep this manual for future reference.

CONTENTS

GENERAL SAFETY RULES FOR WOODWORKING MACHINERY	1
SAFETY RULES FOR HORIZONTAL BAND RESAW	4
MACHINE SPECIFICATIONS.....	8
LIFTING THE MACHINE.....	10
UNPACKING AND CHECKING CONTENTS	12
CLEANING THE MACHINE.....	13
INSTALLING MACHINE.....	14
LEGEND OF THE MACHINE (FRONT VIEW).....	15
LEGEND OF THE MACHINE (BACK VIEW)	16
CONTROL PANEL.....	17
LAYOUT OF VARIOUS LIMIT SWITCHES	30
ELECTRIC WIRING DIAGRAM	31
CONNECTING THE DUST HOOD OUTLET.....	36
CONNECTING THE AIR CIRCUIT	37
FILTER/REGULATOR/LUBRICATOR UNIT.....	38
OIL MIST COOLER.....	39
ADJUSTING OIL MIST FLOW RATE	40
INSPECTING AND ADJUSTING SAWBLADE TENSION.....	41
ADJUSTING SAWBLADE TRACK (FORWARD/BACKWARD DIRECTION).....	45
ADJUSTING SAWBLADE TRACK (RIGHTWARD/ LEFTWARD DIRECTION)	47
ADJUSTING CONVEYOR BELT TRACKING	49
ADJUSTING THE LOADING PRESSURE OF INFEED PRESSURE ROLLER.....	50
CONVENIENT WOOD INFEED	51
MAINTENANCE.....	52
TROUBLE SHOOTING.....	56
HYDRAULIC SCHEMATIC.....	57

GENERAL SAFETY RULES FOR WOODWORKING MACHINERY



WARNING

Do not attempt to operate until you have read thoroughly and understood completely all instructions, rules etc. contained in this manual. Failure to comply can result in accidents involving fire, electric shock, or serious personal injury. Keep this operation manual and review frequently for continuous safe operations.

1. Know your machine. For your own safety, read the operation manual carefully. Learn its applications and limitations, as well as specific potential hazards pertinent to this machine.
2. Make sure the machine is properly grounded.
3. Keep guards in place and in working order. If a guard must be removed for maintenance or cleaning, make sure it is properly reattached before using the machine again.
4. Remove adjusting keys and wrenches. Form the habit of checking to see that keys and adjusting wrenches are removed from the machine before turning it on.
5. Keep the work area clean. Cluttered areas and work benches increase the likelihood of an accident.
6. Do not use in dangerous environments. Do not use the machine in damp or wet locations or exposure to rain. Keep the work area well illuminated.
7. Keep children away. All visitors should be kept at a safe distance from the work area.
8. Make workshop childproof. With padlocks, master switches, or by removing starter keys.

GENERAL SAFETY RULES FOR WOODWORKING MACHINERY

9. Do not force the machine. It will do the job better and be safer at the rate for which it was designed.
10. Use the right tools. Do not force the machine or attachments to do a job for which they were not designed for. Contact the manufacturer or distributor if there are any questions about the machine's suitability for a job.
11. Wear proper apparel. Avoid loose clothing, neckties, rings, bracelets, or jewelry which could be caught in moving parts. Nonslip footwear is recommended. Wear protective hair covering to contain long hair.
12. Always use safety glasses. Use face or dust masks if the operation area has too much sawdust. Do not wear general glasses, because they do not resist impact. They are not safety glasses.
13. Secure work.
14. Always keep proper footing and balance.
15. Maintain machine in top condition. Keep the machine clean for the best and safest performance. Follow instructions for lubricating and changing accessories.
16. Disconnect the machine from the power source before servicing and when changing accessories, or when mounting and remounting motor.
17. Avoid accidental starting. Make sure the switch is in the "off" position before plugging in the power cord.
18. Use recommended accessories. Consult the operating manual for recommended accessories.
19. Check for damaged parts. Before further use of the machine, guards and other safety parts should be carefully checked to make sure that it will operate properly and perform the intended function. Check for alignment of moving parts, binding of moving parts, broken parts, mounting, or any other condition that may affect operation. Guards or other parts that are damaged should be properly repaired or replaced.

GENERAL SAFETY RULES FOR WOODWORKING MACHINERY

20. Never leave the machine running unattended. Turn the power off. Do not leave the machine until it comes to a complete stop.
21. Do not use the machine while under the effects of drugs, alcohol, or any medication.
22. Always wear a face or dust mask if machinery operation produces a lot of saw dust and or wood chips. Always operate the machine in a well-ventilated area and provide for proper dust removal. Use a wood dust collection system whenever possible.
23. The HR150 Resaw is intended for sawing wood only. The machine must not be used for other purposes such as cutting ice, metal or any other materials.
24. The blade is very sharp. Always wear safety gloves when handling the blade.
25. Never clean the blade or blade wheels with a brush or a scraper during sawmill operation.
26. Always wear ear protection when operating this machine.

SAFETY RULES FOR HORIZONTAL BAND RESAW

1. Do not attempt to remove any object from the conveyor belt when the machine is running.
 2. The sawblade is very sharp. Care should be taken when replacing the sawblade.
 3. Turn the power off before performing maintenance or servicing.
 4. Keep all guards in place before starting the machine.
 5. Always keep the sawblade sharp.
 6. Before installation of the blade, inspect it for damage and cracks. Use properly sharpened blades only. Always handle the blade with extreme caution. Use suitable carrier equipment for transporting the blades.
-
1. If sawblade breaks, turn the power off immediately. The operator should stand away from the machine until it comes to a complete stop.
 2. When turning the power on for checking blade tracking, the operator should stand the one side. This will prevent the danger of blade slip-out or breakage.
 3. Use the proper feed speed according to wood material.
 4. Make sure the sawblade is properly tensioned. Excessive tension may cause blade breakage.
 5. Make sure the machine is properly ground to avoid the danger of electric shock.
 6. Before feeding wood into the machine, check if it contains nails or metallic objects or not.
 7. Never clean the blade or blade wheels with a brush or a scraper during sawmill operation.



SAFETY RULES FOR HORIZONTAL BAND RESAW

8. The blade tension should be released when the machine is not in use (e.g.: after a shift). There should be information on the machine that it is necessary to tension the blade before starting to use the machine again.
9. Before installation of the blade, inspect it for damage and cracks. Use only properly sharpened blades. Always handle the blade with extreme caution. Use suitable carrier equipment for transporting the blades.

SAFETY RULES FOR HORIZONTAL BAND RESAW

Safety Labels Description

See Table 1-1. Pictogram decals used to warn and inform the user about danger in the saw.

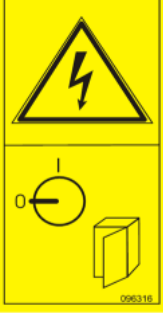
Decals View	Decal Number	Description
	096317	Carefully read the operator's manual before operating the machine. Observe all safety instructions and rules when operating.
	099220	Close all gaurds prior to operating the machine.
	099221	Keep all persons at a safe distance from work area when operating the machine.
	096316	Opening of the electrical box is possible only when the switch is in the "O" position.

SAFETY RULES FOR HORIZONTAL BAND RESAW

	<p>116614</p>	<p>CAUTION! Pinch Point</p>
	<p>S12004G</p>	<p>Always wear eye protection equipment when operating this machine.</p>
	<p>S12005G</p>	<p>Always wear ear protection equipment when operating this machine.</p>
	<p>501465</p>	<p>CAUTION! Always wear safety boots when operating this machine.</p>
	<p>116615</p>	<p>Always Lockout the main power in the off position when performing maintenance.</p>
	<p>501467</p>	<p>Lubrication point.</p>
	<p>P85070</p>	<p>CE sign.</p>

MACHINE SPECIFICATIONS

HR150 SPECIFICATIONS *

HR150 Super, Power Options

One 15kW (20HP) Motor, 230V

Part #: HR150SEA20

One 15kW (20HP) Motor, 380V 50Hz

Part #: HR150SEH20

One 18.5kW (25HP) Motor, 460V/60Hz

Part #: HR150SEC20

HR150 Manual Power Options

One 15kW (20HP) Motor, 230V

Part #: HR150EA20

One 15kW (20HP) Motor, 380V 50Hz

Part #: HR150EH20

One 18.5kW (25HP) Motor, 460V/60Hz

Part #: HR150EC20

Blade

Length - 4265mm (168")

Width - 32mm - 35mm (1 ¼" - 1 ½"),

Thickness - 1.07mm (0.042")

Linear Blade Speed: 24m/s

Blade Wheel

Diameter - 710mm (28")

Type - Steel, dynamically balanced

Feed System

Conveyor Belt- 285mm x 5480mm (11.22" x 215 ¾")

Feed Rate - Variable 5 to 25m/min (16 to 82 feet/min)

Power - 0.75kW (2HP)

Cutting Capacity

Min. Cut Height - 5mm (.2")

Max. Cut Height - 120mm (6 ¾")

Max. Material Height - 250mm (10")

Min. Material Length - 300mm (12")

Max. Material Length - N/A

Min. Width - 25mm (1")

Max. Width - 300mm (12")

Dimensions & Requirements

Packing Dimensions Frame - 1892mm x 1254mm x 964mm (74" x 50" x 38")

Packing Dimensions Conveyor - 2870mm x 640mm x 600mm (113" x 25 1/4" x 24")

Length - 2794mm (110")

Width - 2210mm (87")

Height - 964mm (38")

Weight - 790kgs (1,742lbs)

MACHINE SPECIFICATIONS

Noise Level **$L_{EX8} = 87\text{dB(A)}^{12}$**

¹The noise level measurement was taken in accordance with PN-EN ISO 3746 Standard. The noise exposure level given above concerns an 8-hour work day. Value for associated uncertainty $K=4\text{dB}$.

² The figures quoted are emission levels and are not necessarily safe working levels. Whilst there is a correlation between the emission and exposure levels, this cannot be used reliably to determine whether or not further precautions are required. Factors that influence the actual level of exposure of the workforce include the characteristics of the work room and the other sources of noise etc. i.e. the number of machines and other adjacent processes. Also the permissible exposure level can vary from country to country. This information, however, will enable the user of the machine to make a better evaluation of the hazard and risk.

LIFTING THE MACHINE

SAWDUST EXTRACTOR SPECIFICATION³

Maximum Capacity:	1200m ³ /h
Collector Inlet Diameters (in front of fan):	145 mm
Electric Motor Horsepower:	1,5 kW
Number of Sacks for Waste	2 pc
Total Capacity of Sacks	0.25 m ³
Pressure drop	1,5 kPa (0.22 psi) ⁴
Weight	110 kg
Conveying Speed When 10 m Long Hose Is Used	20 m/s



CAUTION

Always turn on the dust extractor before starting the machine.

³ External chip and dust extraction equipment with fixed installation are dealt with EN 12779:2016-04

⁴The pressure drop between the inlet of the capture device and the connection to the CADES should not exceed 1.5 kPa (for the nominal air flow rate). If the pressure drop exceeds 1.5 kPa the machine might not be compatible with conventional CADES.

LIFTING THE MACHINE

This machine should be lifted or moved only by using a forklift. Make sure the loading capacity of the forklift is enough to lift the machine.

The weight of HR150 is shown as below:

Net weight: 790 kgs (1742 lbs.)

Gross weight: 895 kgs (1973 lbs.)

Lifting a packed machine and unpacked machine is shown below. Always pay attention to the machine balance when lifting the machine.



Lifting a packed machine



Lifting an unpacked machine

UNPACKING AND CHECKING CONTENTS

The twin head horizontal band resaw is shipped in one wooden crate.

Carefully unpack the machine to avoid damage to the machine.

Check the machine to see if all parts are present and free of damage. If any parts are missing or damaged, contact your local distributor or the machine manufacturer immediately.



WARNING

Do not attempt to assemble or operate the machine without all parts are present and in working order.

CLEANING THE MACHINE

Before shipment, the machine is coated with a rust-preventive oil to prevent rusting during transportation.

Once you receive and unpack the machine, thoroughly remove rust preventive oil. To do this, use a clean cloth soaked in an appropriate solvent for removing the rust preventive oil.



CAUTION

Do not use lacquer thinners or any volatile solvents, because they can damage the painted surfaces of the machine.

INSTALLING MACHINE

IMPORTANT! Before starting to use the resaw, you must meet the following conditions:

- Set up the machine on firm and level ground. Secure the sawmill to the ground to prevent moving during operation.
- A concrete foundation and anchored bolts are recommended.
- When your HR150 resaw is used indoors, it must be operated with a sawdust exhaust system connected.
- The HR150 resaw must not be used outdoors when it is raining/snowing. In such a case, the machine must be placed under a roof or indoors.
- The machine should work in temperatures of -15°C to 40°C (5°F to 104°F) only.
- The light intensity in the operator's work-place must be 300 lux⁵.
- When installing the machine, be sure to leave proper spaces around the machine to facilitate material handling.

⁵ The light source cannot cause the stroboscopic effect.

LEGEND OF THE MACHINE (FRONT VIEW)



1. Feed conveyor
2. Air cylinder for infeed pressure roller
3. Lifting channels for forklift
4. Front door
5. Dust outlet for lower sawblade (ø4")
6. Saw wheel drive motor (20/ 25HP)
7. Control box
8. Infeed pressure roller assembly

LEGEND OF THE MACHINE (BACK VIEW)

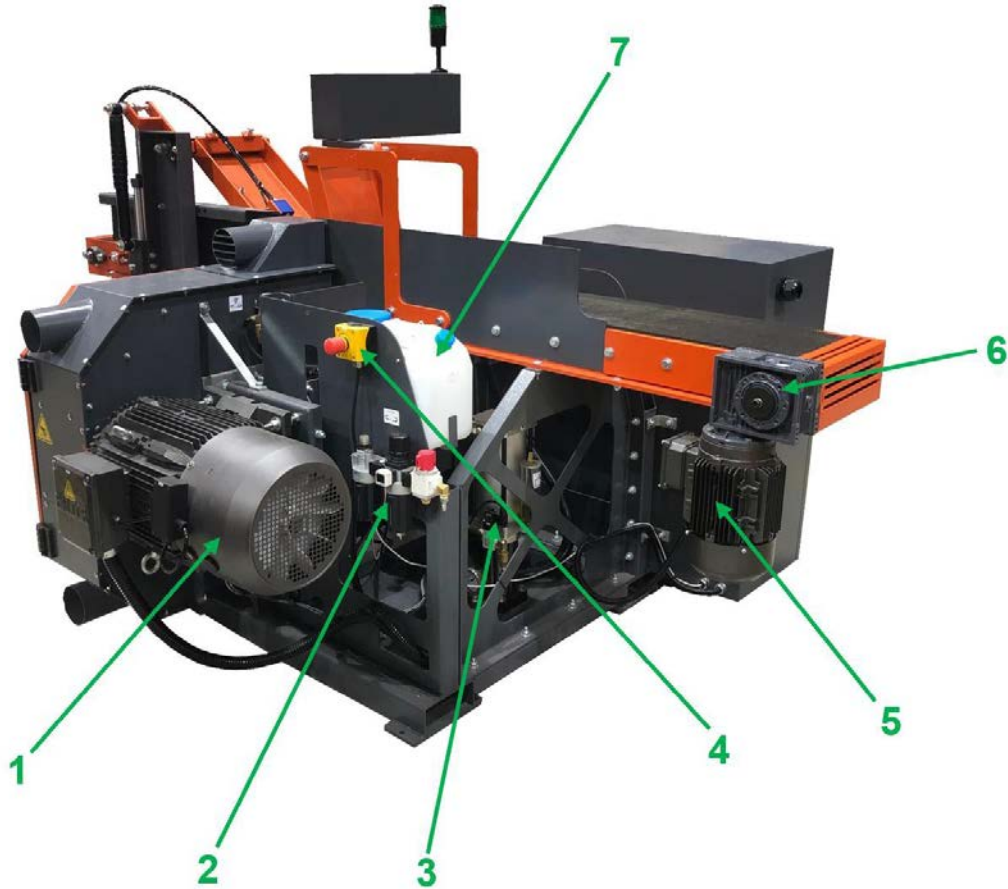

1. Saw wheel drive motor (20/ 25HP)
2. Filter/regulator/lubricator combination unit
3. Air/hydraulic combination unit for sawblade tension
4. Emergency stop switch
5. Conveyor belt drive motor
6. Gear reducer
7. Oil box for oil mist cooler

CONTROL PANEL

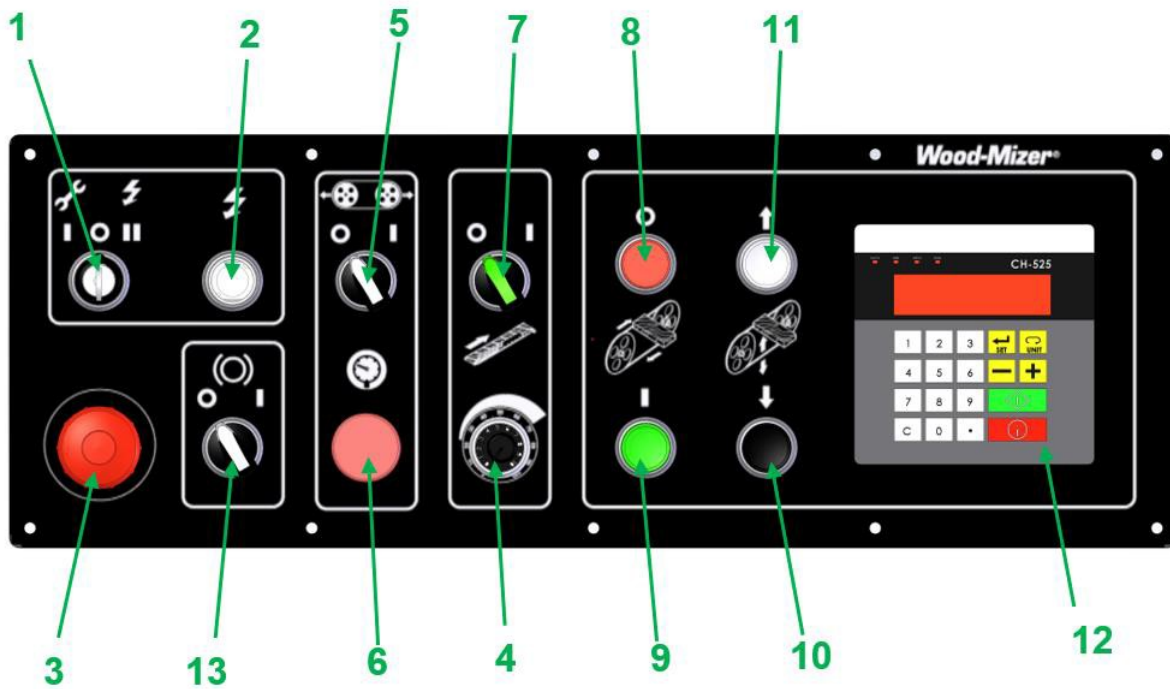

1. KEY SWITCH- MAINTENANCE/ RUN
2. POWER ON CONTROL PANEL SWITCH
3. EMERGENCY STOP SWITCH
4. CONVEYOR BELT SPEED REGULATOR
5. SAWBLADE TENSION SWITCH
6. AIR PRESSURE WARNING LIGHT
7. CONVEYOR BELT START/ STOP TOGGLE SWITCH
8. SAW WHEEL STOP SWITCH
9. SAW WHEEL START SWITCH
10. SAW WHEEL LOWERING SWITCH
11. SAW WHEEL RAISING SWITCH
12. DIGITAL CONTROLLER FOR LOWER SAW WHEEL ELEVATION
13. MAGNETIC BRAKE CONTROL SWITCH

CONTROL PANEL

1. KEY SWITCH- MAINTENANCE/ RUN



- (1) Turn the Key Switch to the left (Maintenance), this activates the switch to tension or release tension on the blades.

Please Note when in Maintenance mode the machine is unable to start, only the tensioning of the blades and the magnetic brake switch are active.

- (2) Turn the Key to the right (Run), allows for normal cutting functions.
- (3) To turn power off, turn the Key switch to the “O” position or press the EMERGENCY STOP SWITCH (2).

2. POWER ON SWITCH

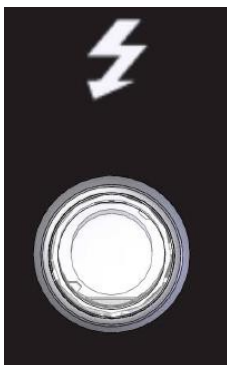

- (1) Press this switch for turning power ON. At this time, the white-color indication lamp lights on.

NOTE

Be sure to turn the Key Switch (1) to maintenance/ run for the power switch to activate.

- (2) When this switch is pressed, the machine is then under a powered condition and ready for operation.
- (3) To turn power off, press the EMERGENCY STOP SWITCH (3) or turn the Key switch (1) to O position.

CONTROL PANEL

3. EMERGENCY STOP SWITCH



- (1) During operation, if any abnormal motion or emergency condition occurs, the operator should press the "EMERGENCY STOP SWITCH." Then all driven motions of the machine will stop.
- (2) Before restarting the machine, you need to turn the "EMERGENCY STOP SWITCH" clockwise to reset. Otherwise, the machine can't start.
- (3) When the "EMERGENCY STOP SWITCH" is pressed, the power source will shut off immediately.

4. CONVEYOR BELT SPEED REGULATOR



- (1) The feed conveyor belt is driven by an induction motor in combination with a gear reducer.
- (2) The conveyor belt feed speed is controlled by a frequency inverter, providing variable speed control.
- (3) Changing the conveyor belt speed is made simply by turning the "CONVEYOR BELT SPEED REGULATOR."

CONTROL PANEL

5. SAWBLADE TENSION SWITCH



NOTE

The Key Switch (1) must be turned to Maintenance for the sawblade tension switch to activate.

(1) Turn this switch to the Left for loosening sawblade tension.

(2) Turn this switch to the Right for tightening sawblade tension

6. AIR PRESSURE WARNING LIGHT

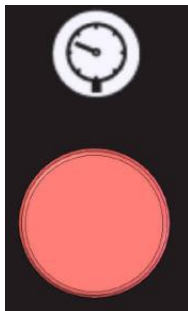

(1) This is an Air pressure warning, if the air pressure drops below 4 Bar or a blade breaks the machine will automatically shut down and the air pressure warning light will start blinking to inform you that there has been a loss of pressure.

7. CONVEYOR BELT START/ STOP TOGGLE SWITCH

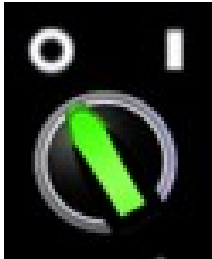

- (1) Turn this switch to the left to stop the conveyor belt.
- (2) Turn this switch to the right to start the conveyor belt.

8. SAW WHEEL STOP SWITCH

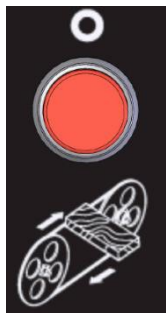

- (1) Press this switch for stopping the saw wheels running.

9. SAW WHEEL START SWITCH



- (1) Press this switch for starting the saw wheel running.
- (2) This switch is effective only when the Key Switch (1) has been turned to the run position and there is enough air pressure.
- (3) Operating pressure of 5-7 Bar required.

10. LOWER SAW WHEEL LOWERING SWITCH

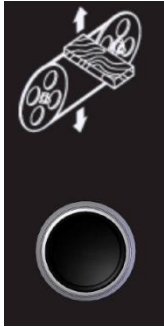

- (1) Press this switch, then the lower saw wheels will lower.
- (2) Lowering distance is displayed on the digital controller (12).
- (3) This switch is a jog switch. When pressing on this switch, the saw wheels will lower. Release this switch, then the saw wheels lowering motion will stop immediately.

11. LOWER SAW WHEEL RAISING SWITCH

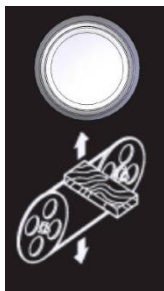

- (3) Press this switch, then the lower saw wheels will raise.
- (4) The raising distance is displayed on the digital controller (12).
- (5) This switch is a jog switch. When pressing on this switch, the saw wheels will rise. Release this switch, then the saw wheels raising motion will stop immediately.

12. DIGITAL CONTROLLER FOR LOWER SAW WHEEL ELEVATION



- (1) This digital controller indicates the saw wheels elevation and providing quick setting of thickness of cut.

CONTROL PANEL

13. MAGNETIC BRAKE CONTROL SWITCH



- (1) This switch is for releasing the magnetic brake in order to track and align blades.

- (2) This switch is effective only when the Key Switch (1) has been turned to the maintenance position.

(MODEL CH-525)

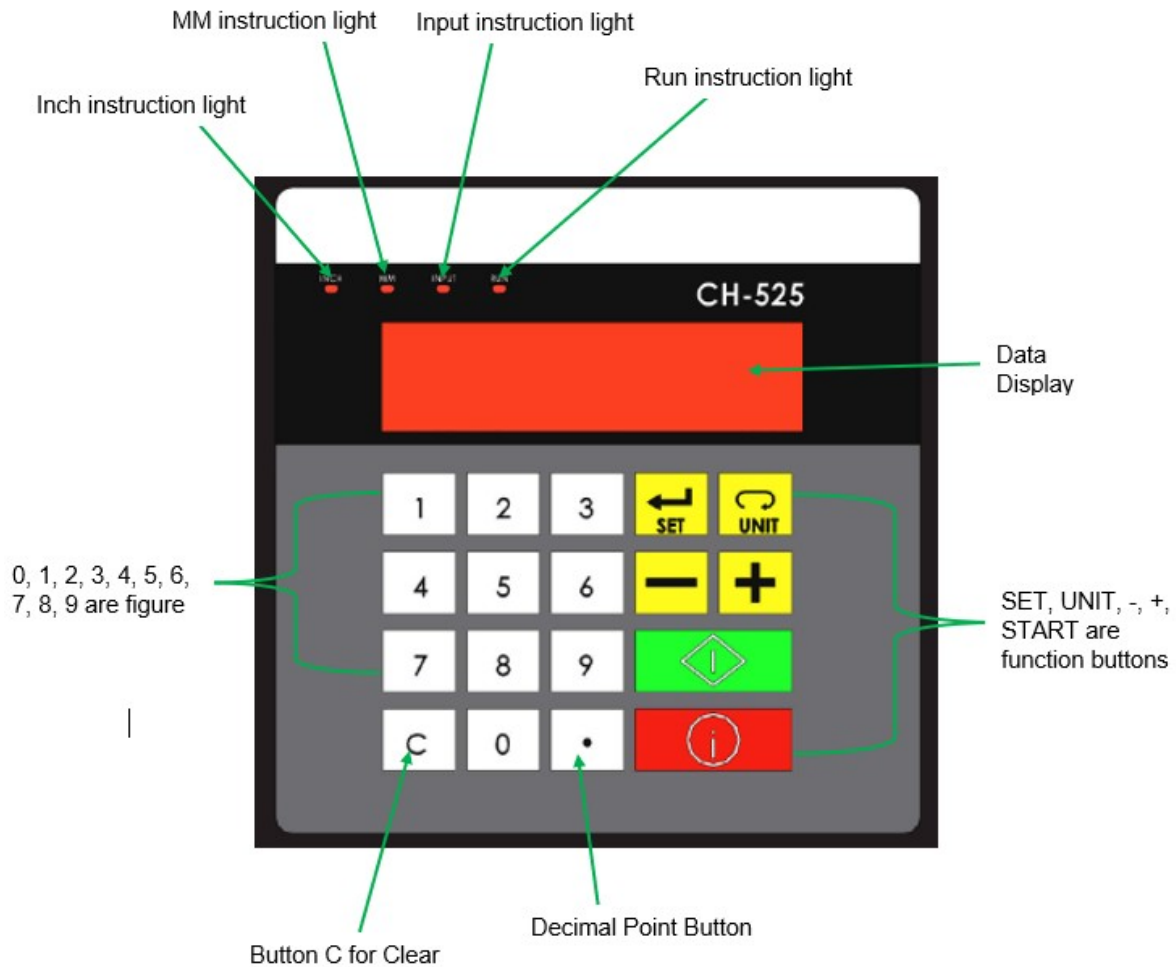

- 1) FIGURE BUTTONS ARE FROM 0 TO 9.
- 2) BUTTON C IS FOR CLEAR.
- 3) (.) BUTTON FOR SETTING THE DIGITS AT RIGHT SIDE OF THE DECIMAL POINT.
- 4) SET IS A BUTTON FOR SETTING DATA.
- 5) UNIT IS A BUTTON FOR TRANSITING DIMENSION UNITS.

- 6) (-) FOR MANUAL OPERATION TO DEDUCT THE FIGURE.
- 7) (+) FOR MANUAL OPERATION TO INCREASE THE FIGURE.
- 8) "START" IS A BUTTON TO START.
- 9) "STOP" IS A BUTTON TO STOP AND STOP ALL OPERATIONS MEANWHILE.

OPERATING INSTRUCTION FOR CORRECTING DATA

In accordance with the dimension of the actual material, press "SET" button and 0 will show on the display. Use correct figures and press "0-9" buttons, then press SET button for 2-3 seconds. The display will start to flash and then stop flashing. The figures put in earlier will be shown and correcting the data is complete. If the time for pressing the "SET" button or input incorrect figures, that means the previous input is ineffective. Operate again.

NOTE: When correcting existing data, the buttons "C", ".", "STOP" can be operated at the same time. Refer to the diagrams below. If the current figure shown on the control unit is 200.1 and the correct one is 100.0, the steps to operate are as the following diagrams demonstrate

Current figure shown is 200.0



STEP 1: Press "SET" button, take your finger off the "SET" button and 0 will show on the display



CONTROL PANEL

STEP 2: Press "1" button followed by pressing "0" button twice.



STEP 3: Press "SET" button and hold for 2-3 seconds. Figure 100.0 will be displayed. Correcting the data is complete.



DIMENSION UNIT SELECTING & DESCRIPTION OF CHANGE

The user can choose between INCH and MM in accordance with their common use. This control unit can change the dimension units swiftly by pressing the "UNIT" button. A light will indicate on the top left corner which unit is currently selected.

STEP 1: Current dimension unit shown is MM, Press the "UNIT" button to toggle between INCH and MM.



CONTROL PANEL

STEP 2: Once you have pushed the “UNIT” button the size will automatically change accordingly.



DESCRIPTION OF AUTOMATIC START OPERATING

If the figure shown on this control unit is 100.0 and we need to increase it to 200.0 press “SET” button first. The display will show 0. Then input the new figure we want to increase to and finally press “START” button.

NOTE: During operating of INPUT or START, if the “STOP” button is pressed, this control unit will stop running immediately and go back to the condition of repose.

Current figure shown is 100.0



CONTROL PANEL

STEP 1: Press "SET" button. Display will show 0.



STEP 2: Press "2" button, followed by pressing "0" button twice. Display will show 200.



STEP 3: Press "START" button. The control unit starts to run and the figure on the display changes Back to 100 and begins to increase until it reaches the set size.



CONTROL PANEL

Problem	Search for Failure	Correction
The display fails to show figures.	Inspect incoming voltage, it should be 220V or AC110V	Make sure wires are secure, ensure sufficient grounding.
	Inspect Fuse	Replace with a new 1A fuse.
	If the above two points are inspected and not faulty, it means the control unit is out of order.	Send back to the supplier for repair.
Figures on the display do not change when head is moved up and down or you lose correct sizing when moving the head.	Inspect for loose wires and ensure the wires to the sensor are not damaged	Tighten the loose connection, replace wiring if damaged.
	Inspect the distance that the sensor is positioned in relation to the sensor board.	Adjust sensor position to be within 1mm from sensor board.

LAYOUT OF VARIOUS LIMIT SWITCHES

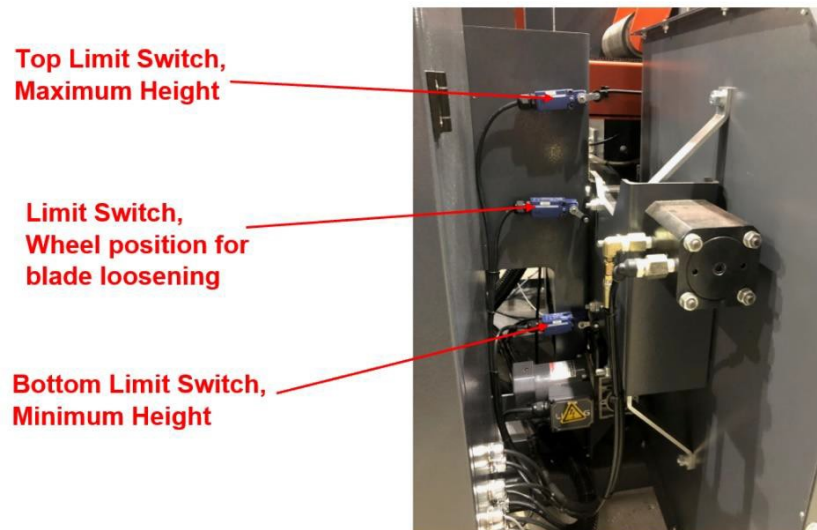

These 3 limit switches are provided at the right side of the machine back.

1. LIMIT SWITCH FOR LOWER SAW WHEEL POSITION FOR BLADE LOOSENING

- (1) When performing sawblade loosening on lower saw wheels, this limit switch is used to prevent the lower saw wheel from colliding against the conveyor table.
- (2) In case the lower saw wheel position displayed on the digital controller (12) is less than 30, sawblade loosening cannot be performed. This will avoid a collision between the lower saw wheel and the conveyor table.

The limit switch prevents the lower saw wheel from colliding against the convey



ELECTRIC WIRING DIAGRAM



CAUTION

It is recommended that a 30mA Ground Fault Interrupter (GFI) be used.

1. Before connecting the power wires of the machine to your factory's power source, make sure the voltage, Hz and phase of the machine are same as that of your factory's power source.
2. The power wire connection points are provided at the left bottom corner in the electrical cabinet.
3. The wires marked with "L1, L2, L3" are power wires.
4. The wire marked with "PE" is a grounding wire, which should be properly connected to avoid a danger of electrical shock.
5. Once power wires have been connected, check if they are connected tightly to the correct terminals or not.

ELECTRIC WIRING DIAGRAM

460V/ 60Hz- UL

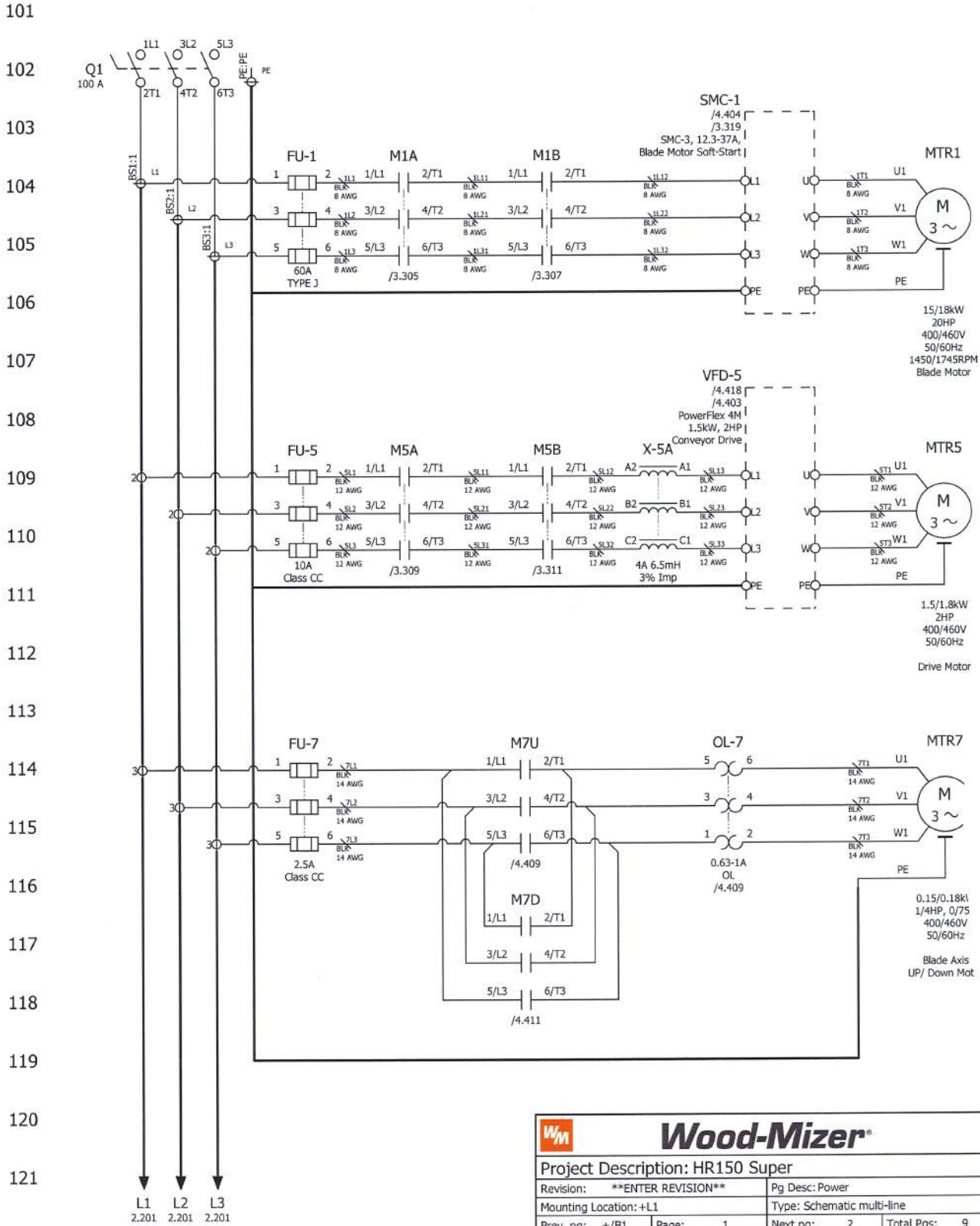

Wood-Mizer®			
Project Description: HR150 Super			
Revision: **ENTER REVISION**	Pg Desc: Power		
Mounting Location: +L1	Type: Schematic multi-line		
Prev. pg: +/B1	Page: 1	Next pg: 2	Total Pgs: 9

ELECTRIC WIRING DIAGRAM

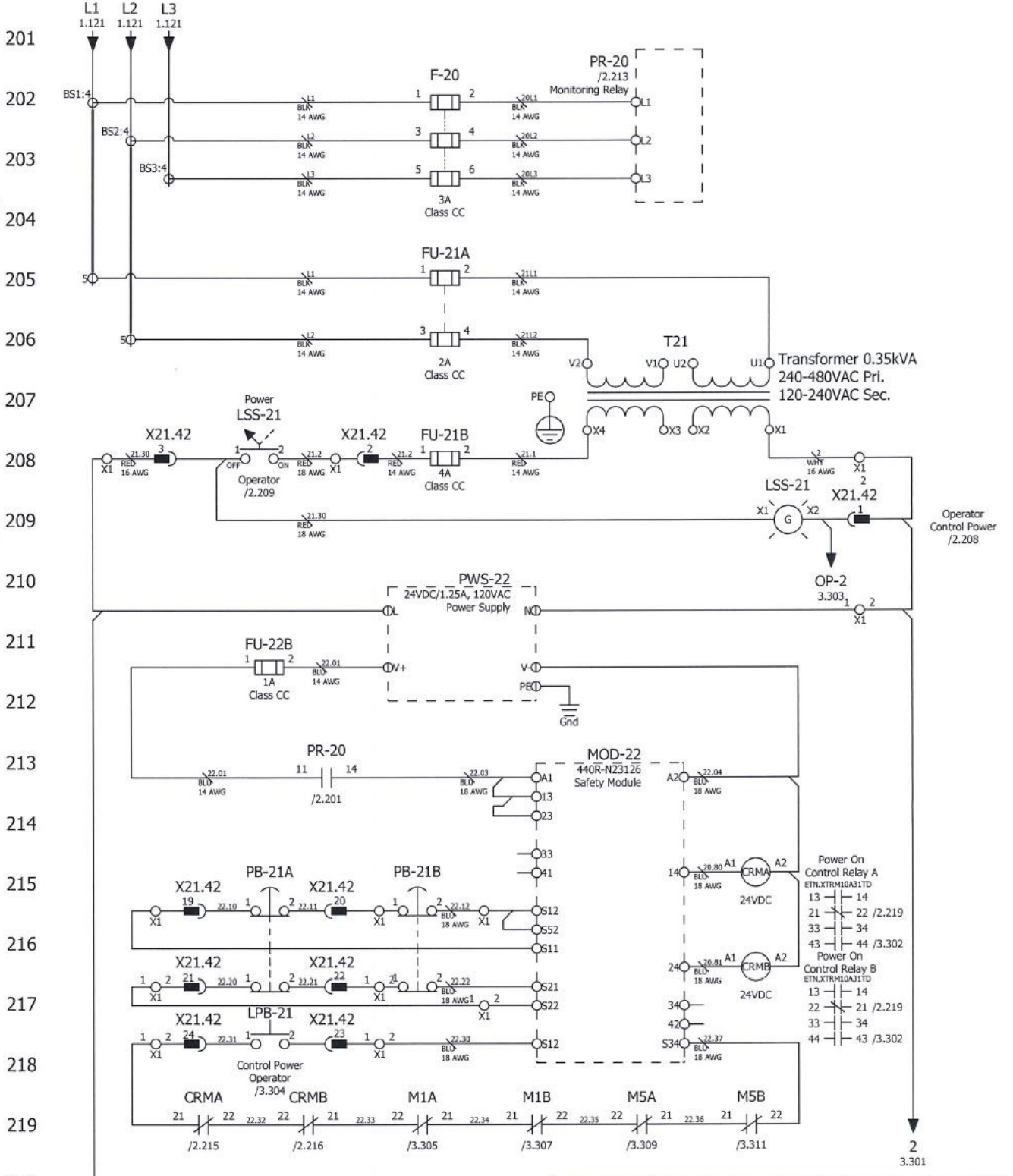

Wood-Mizer®			
Project Description: HR150 Super			
Revision: **ENTER REVISION**	Pg Desc: Control		
Mounting Location: +L1	Type: Schematic multi-line		
Prev. pg: 1	Page: 2	Next pg: 3	Total Pgs: 9

ELECTRIC WIRING DIAGRAM

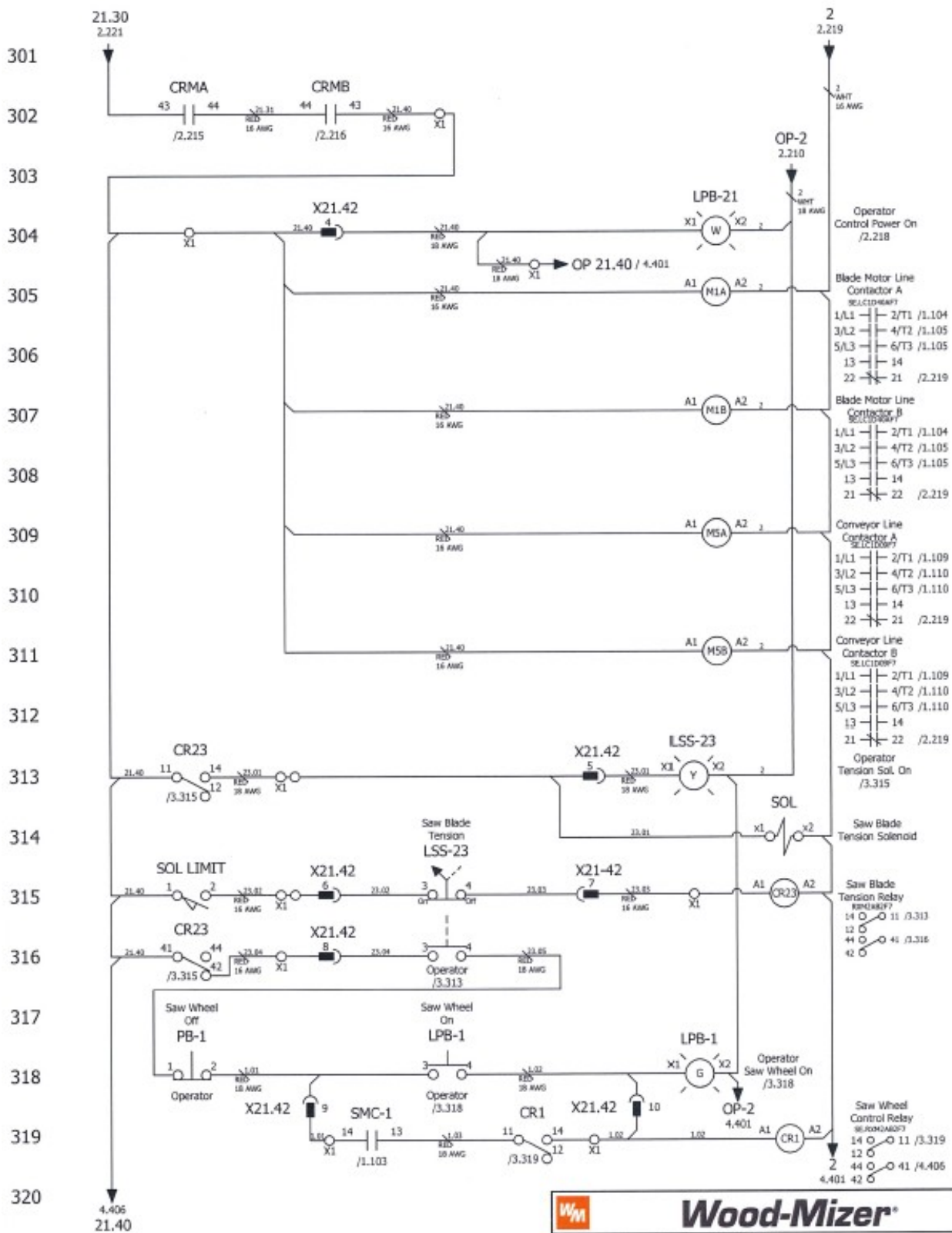

Wood-Mizer®			
Project Description: HR150 Super			
Revision: **ENTER REVISION**		Pg Desc: Control	
Mounting Location: +L1		Type: Schematic multi-line	
Prev. pg: 2	Page: 3	Next pg: 4	Total Pgs: 9

ELECTRIC WIRING DIAGRAM

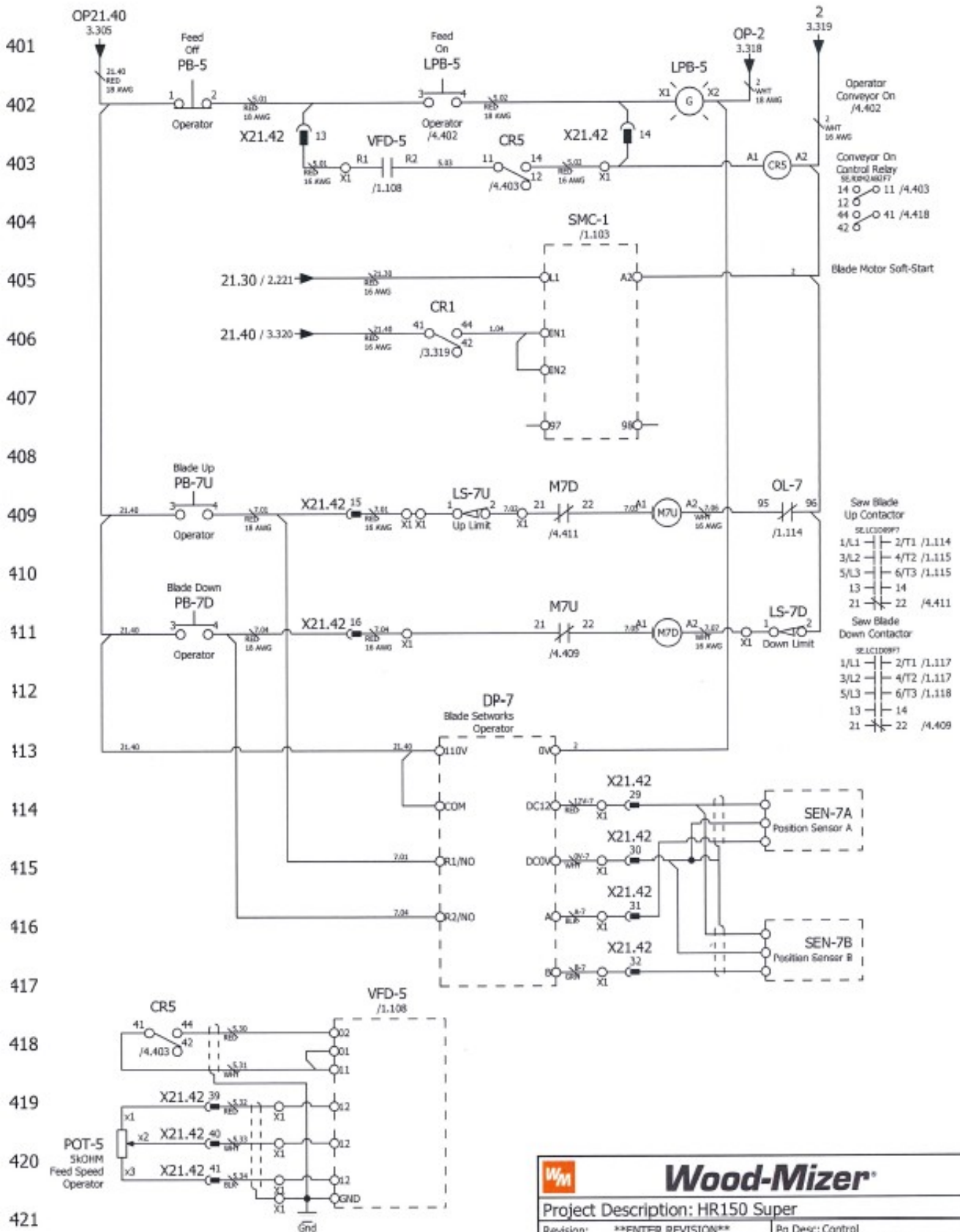

Project Description: HR150 Super	
Revision: **ENTER REVISION**	Pg Desc: Control
Mounting Location: +L1	Type: Schematic multi-line
Prev. pg: 3	Page: 4
	Next pg: +DOC/C1
	Total Pgs: 9

CONNECTING THE DUST HOOD

OUTLET

1. This machine is equipped with three dust hood outlets. Two are located at the right side of the machine, and one is located at the left side.
2. Diameters of all dust hood outlets are all 6".
3. Use 6" flexible hoses to fit to all dust hood outlets, then connect them to a dust collector.



CONNECTING THE AIR CIRCUIT

1. The quick air connector is provided on the filter/regulator/lubricator combination unit (F.R.L. Unit).
2. You need to connect the quick air connector to an air source.
3. The size of the quick air connector is 3/8".
4. The filter / regulator / lubricator combination unit is located at the back-right hand side of the machine.
5. The working air pressure required by the machine is 5~8kg/cm². Adjust air pressure by turning the pressure regulation knob.

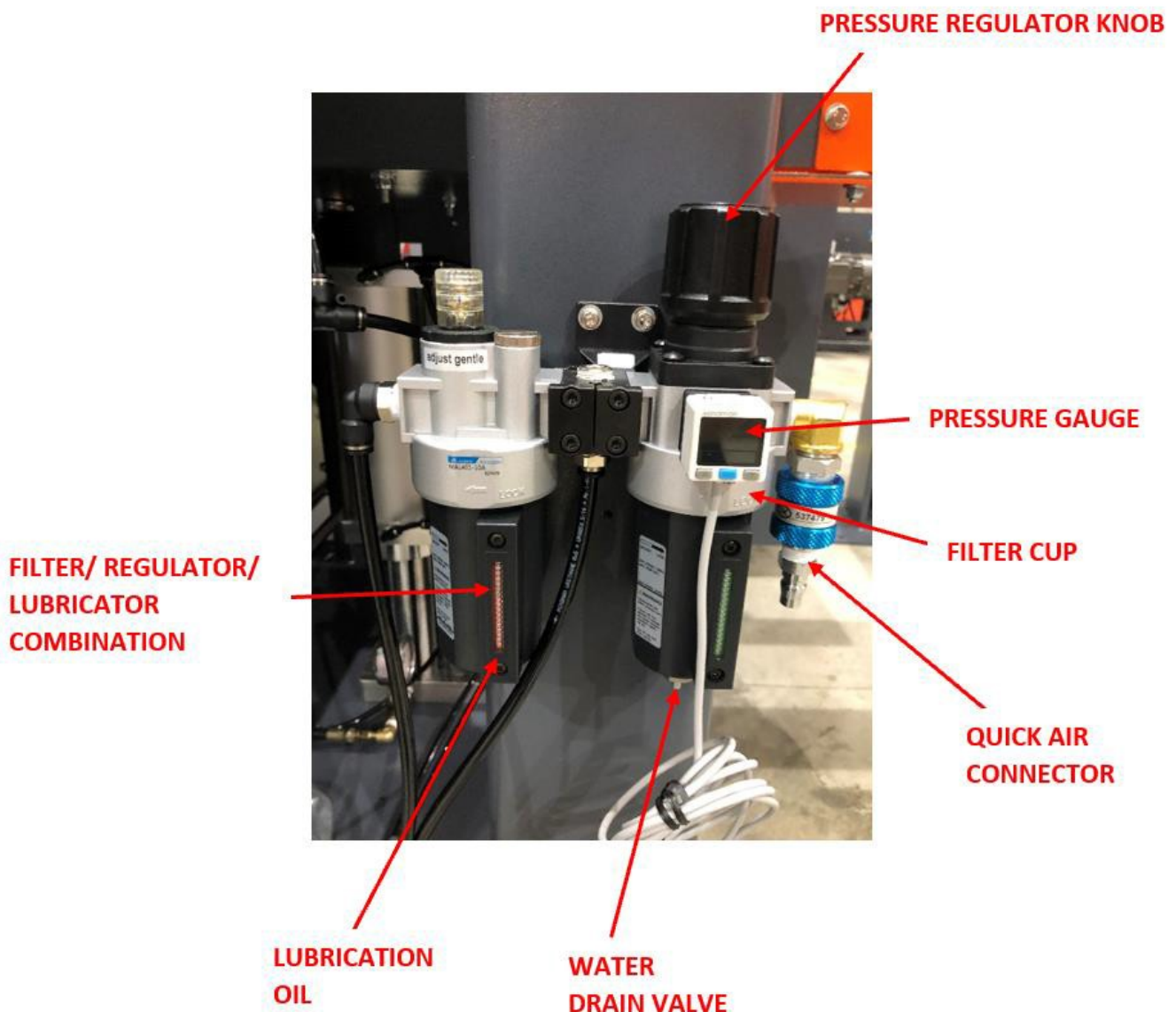

FILTER/REGULATOR/LUBRICATOR (Turbine oil ISO-VG32) UNIT

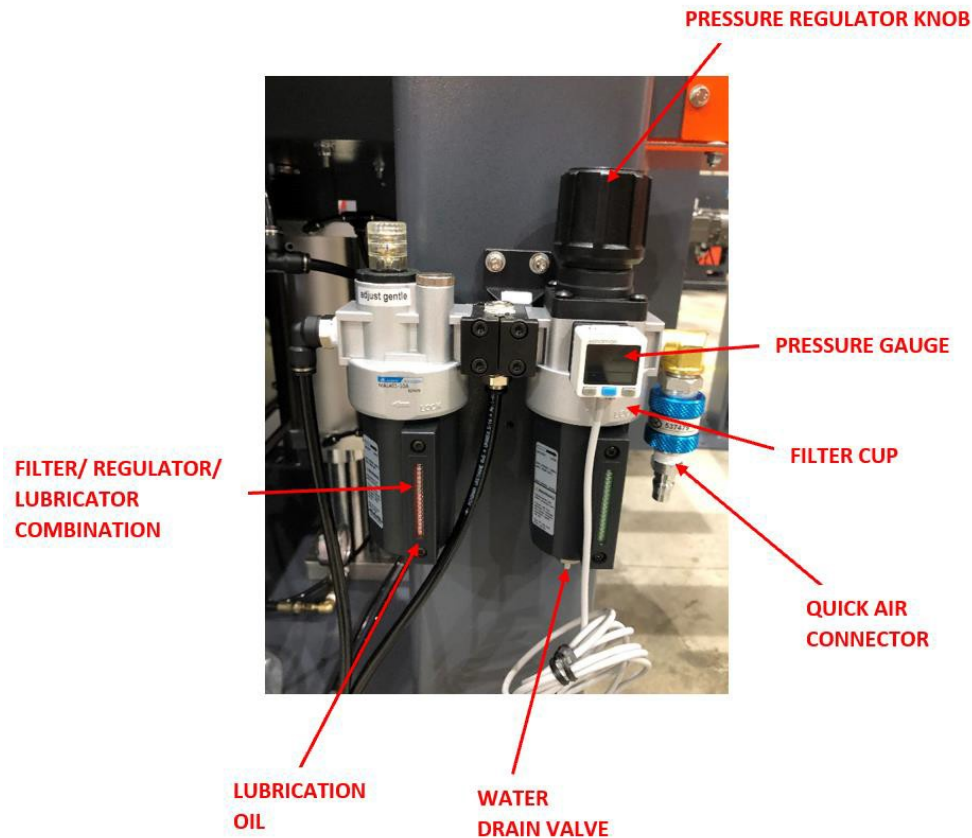

1. **PRESSURE GAUGE.** The pressure for the air system is indicated on the pressure gauge. Working air pressure can be adjusted by turning the pressure regulation knob located on the filter cup. Turn it clockwise for increasing pressure. Turn counter-clockwise for decreasing pressure. Lift the regulation knob before setting pressure. Push it down to fix the pressure setting after pressure has been adjusted. The working air pressure should be set at about 5~7kg/cm².
2. **LUBRICATION OIL CUP.** Periodically check to make sure that there is an adequate amount of oil in the lubrication oil cup. If necessary, fill oil into the lubrication oil cup until it reaches 80% of the cup capacity, ensuring that the air circuit is properly lubricated. It is recommended that Turbine oil ISO-VG32 be used.
3. **FILTER CUP.** Always remember that the moisture contained in air will be condensed and collected in the filter cup. The water accumulated in the filter cup should be released when the water reaches a certain amount. To release water, simply press the drain valve located at the bottom of the filter cup.

OIL MIST COOLER

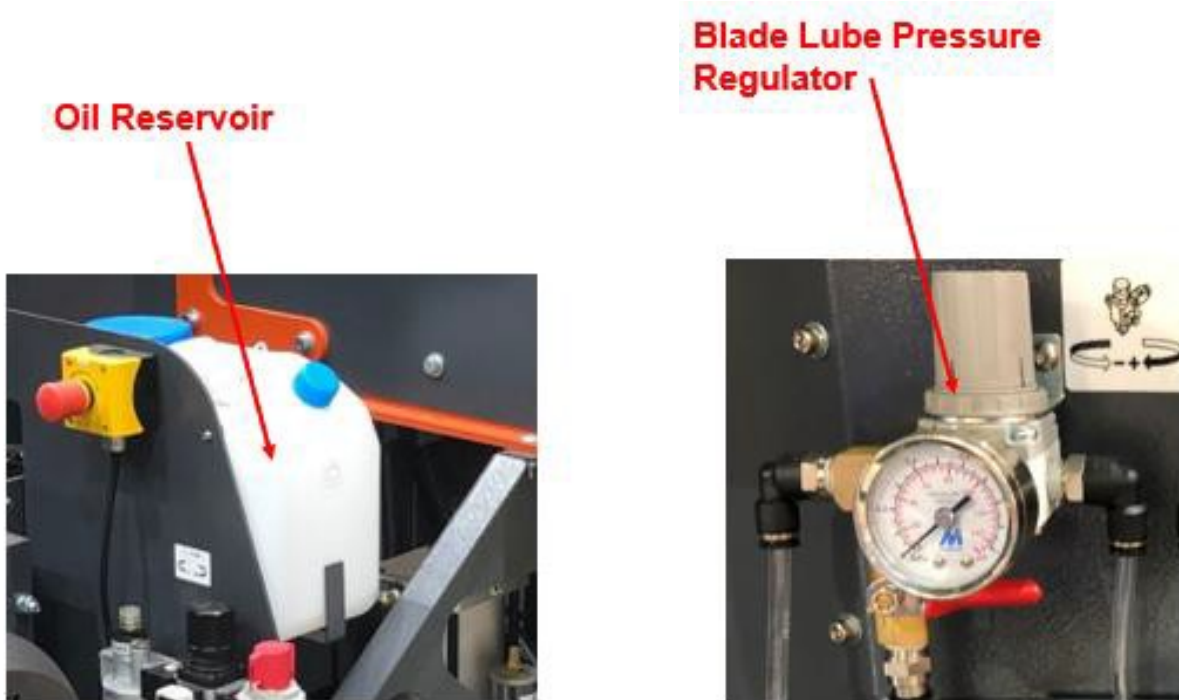

1. This machine is equipped with an oil mist cooler for cooling the upper and the lower sawblades. In addition, the cooler can also remove dusts deposited on the sawblade.
2. The oil mist cooler requires air and oil to operate.
3. The working pressure of the oil mist cooler is about 1-2 kg/cm². Adjust air pressure by turning the pressure regulation knob, located at the back side of the machine.
4. Start the oil mist by turning down the red lever.
5. Use R32 lubrication oil or Bio Lube 210 to fill the oil reservoir until the oil amount reaches 80% of its full capacity.
6. The operator is requested to periodically check the oil amount in the oil box.

ADJUSTING OIL MIST FLOW RATE

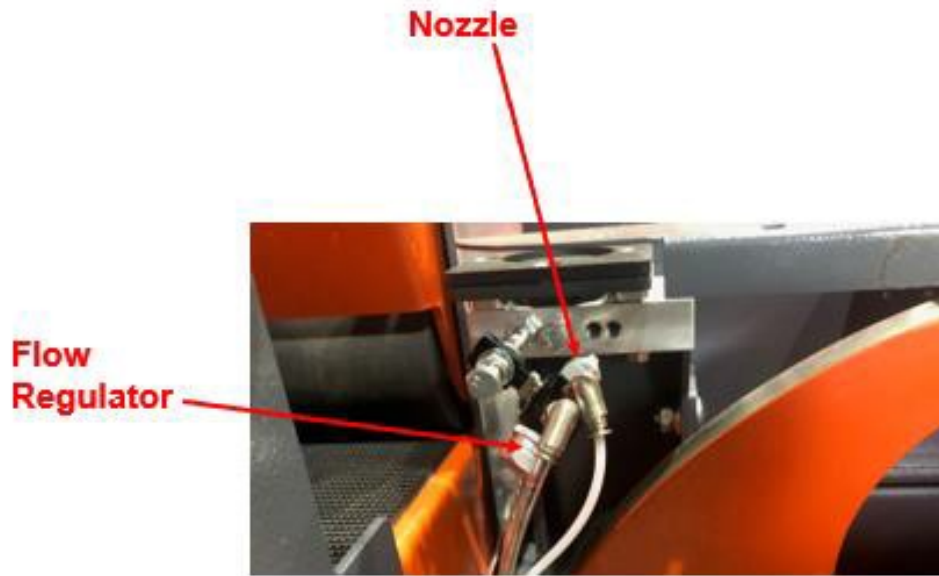

1. Open the front doors before adjusting oil mist flow rate.

 **DANGER**

Make sure the saw wheels have come to a complete stop before opening the front doors

2. Adjusting the oil mist flow rate is made only when the machine is fully stopped.
3. The upper and lower sawblade are cooled through individual nozzles.
4. Adjusting the oil mist flow rate is made by turning the flow rate regulator.
5. Turn the flow rate regulator clockwise for reducing the flow rate. Turn counterclockwise for increasing the flow rate.

INSPECTING AND ADJUSTING SAWBLADE TENSION

When installing a new sawblade, it is necessary to inspect and adjust the sawblade tension. In addition, after the machine has operated for a long period, the sawblade tension may become loose gradually. At this time, it is also necessary to inspect and adjust the sawblade tension.

CAUTION

A loosed sawblade may cause blade slippage.

Inspecting and adjusting sawblade tension according to following procedures:

1. A sawblade tension gauge (optional accessory) shall be applied for inspecting the sawblade tension.



SAWBLADE TENSION GAUGE

INSPECTING AND ADJUSTING SAWBLADE TENSION

2. Fit the sawblade tension gauge onto the sawblade. Make sure the two slot bottoms on the sawblade tension gauge have touched the back side of the sawblade.

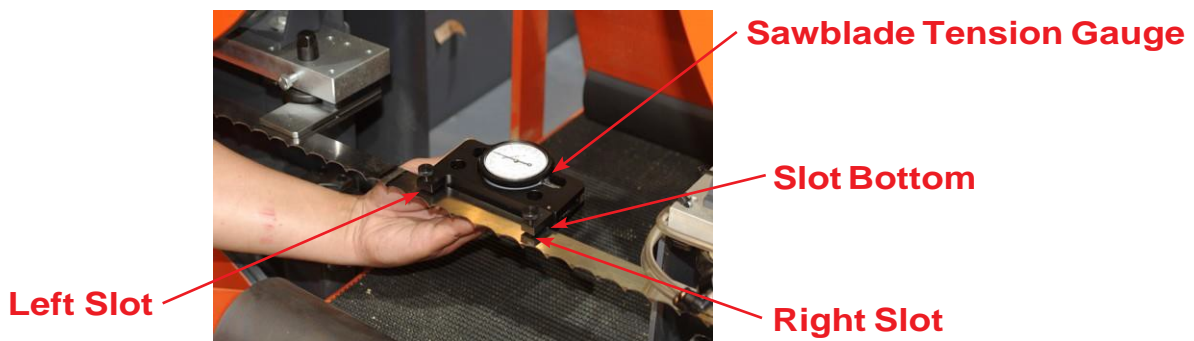

3. First tighten the left fix screw on the sawblade tension gauges.

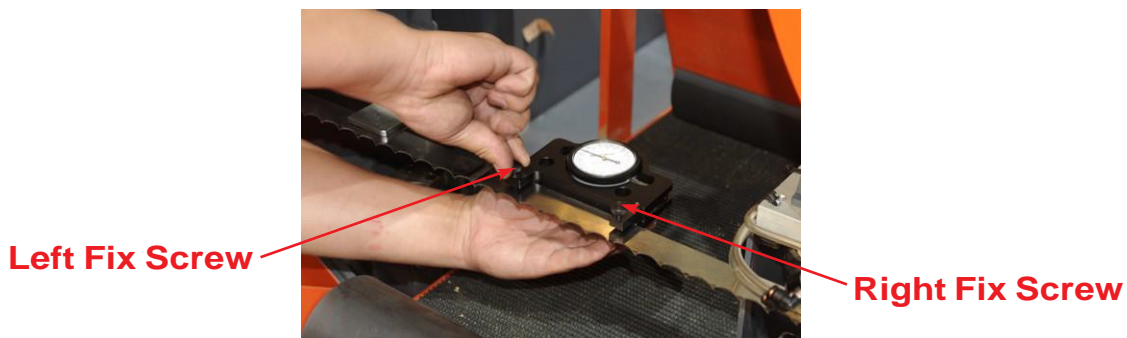

4. Make a micrometric adjustment on the right slot of the sawblade tension gauge by slightly shifting the slot to the right side, until the gauge indicates at graduation 15 (red graduation).

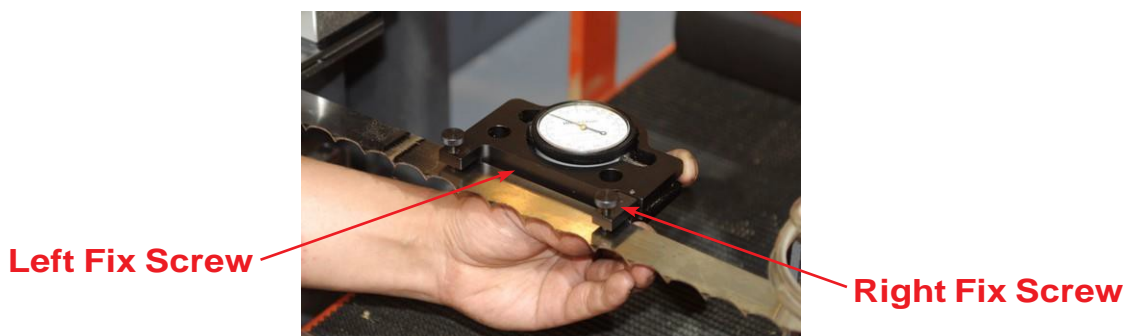

INSPECTING AND ADJUSTING SAWBLADE TENSION

5. Tighten the right fix screw on the sawblade tension gauge.

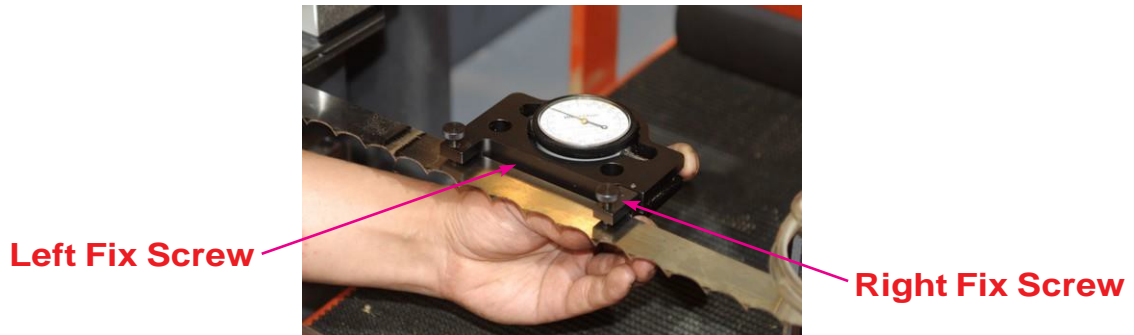

6. Turn the gauge to set it at graduation "0."

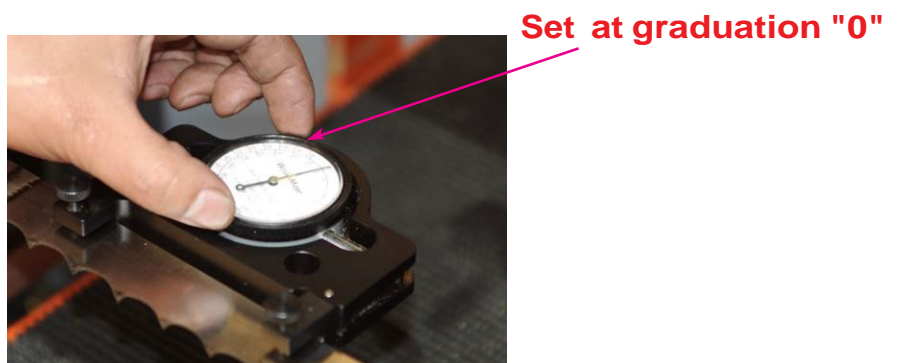

7. Turn the sawblade tension switch (5), located on the operation panel, to the Right position (tighten) for tightening the sawblade.

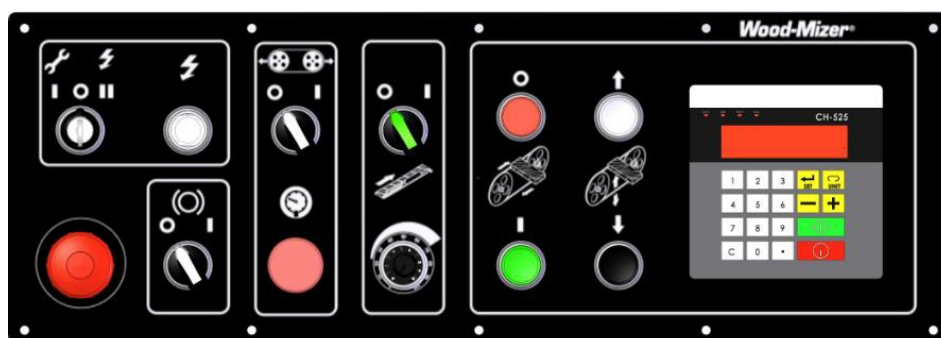

8. Check the sawblade tension indicated on the gauge. The normal sawblade tension should be indicated on the graduation 35-40 (red graduation).

INSPECTING AND ADJUSTING SAWBLADE TENSION

9. If adjusting blade tension is required, turn the air pressure regulator on the air hydraulic combination unit, located at the back side of the machine.

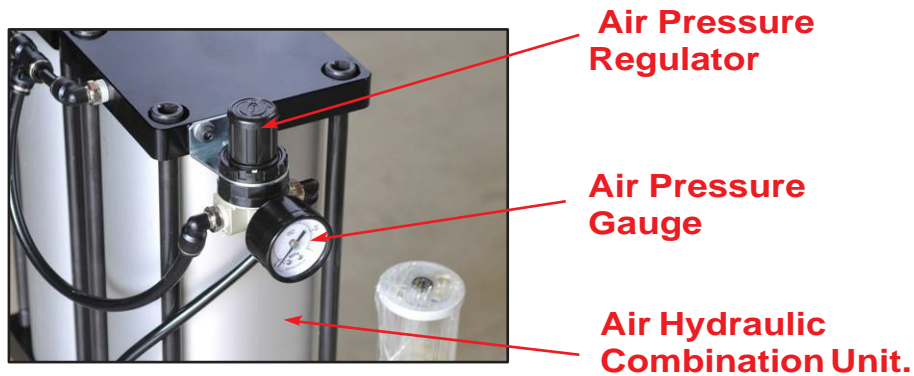

10. Turn this air pressure regulator clockwise for increasing pressure, which will tighten the sawblade tension.

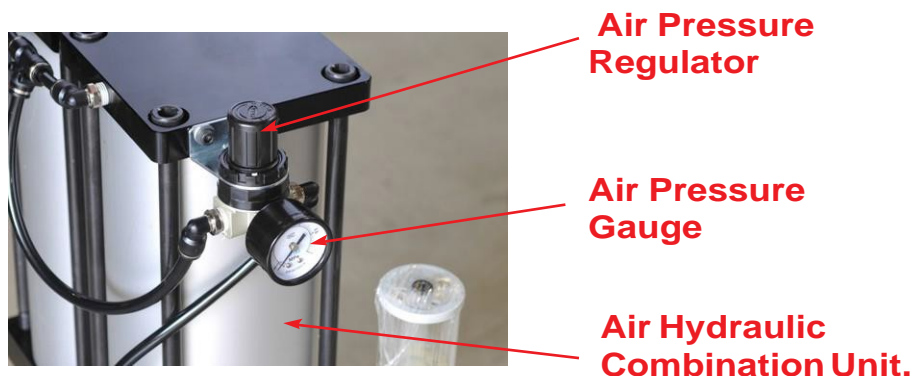

11. For convenience, when making air pressure adjustment it is suggested to ask another person to help look at the indication on the sawblade tension gauge.

12. The hydraulic pressure gauge on the air hydraulic combination unit does not require adjusting, which may automatic vary with the air pressure value. In general, the hydraulic pressure gauge indicates at 48.

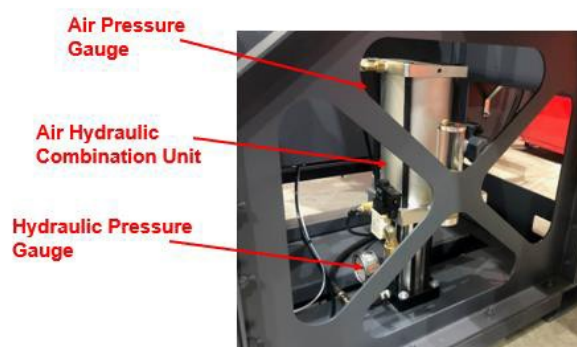

ADJUSTING SAWBLADE TRACK (FORWARD/BACKWARD DIRECTION)

1. Turn power off before conducting sawblade tracking adjustment.
2. Open the saw wheel guard (front doors).
3. Make sure the sawblade tension is proper before adjusting sawblade tracking.
4. Slowly turn the saw wheel by hand, and check the sawblade running track condition.
5. To adjust the sawblade track in forward/backward direction on the drive side saw wheel, loosen the fixing nut (1).

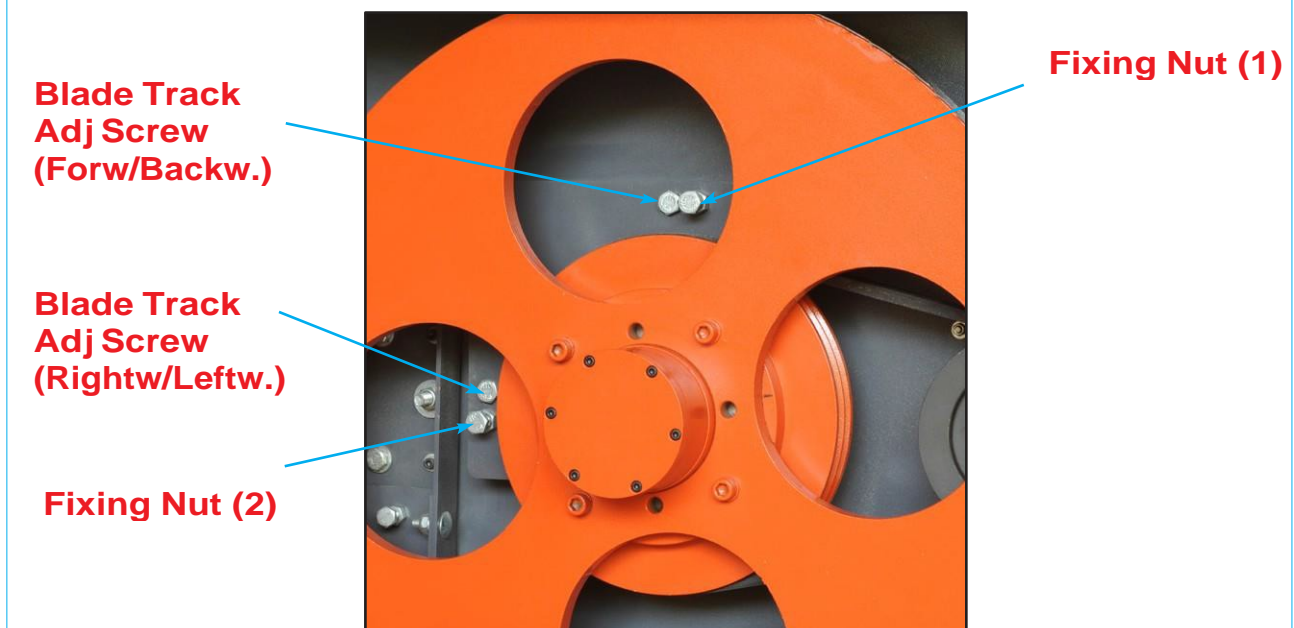

DRIVE SIDE SAW WHEEL

ADJUSTING SAWBLADE TRACK (FORWARD/ BACKWARD DIRECTION)

6. Turn the blade track adjustment screw 1/4 turn counter-clockwise for moving the sawblade forward. Turn the screw 1/4 turn clockwise for moving the sawblade backward.
7. After blade track is adjusted, tighten the fixing nut (1).
8. During track adjustment, slowly turn the saw wheel by hand to check if the sawblade runs on the correct track.
9. The sawblade tracking adjustment on the idle side saw wheel is same as that of the drive side saw wheel.

ADJUSTING SAWBLADE TRACK (RIGHTWARD/ LEFTWARD DIRECTION)

1. Turn power off before conducting sawblade tracking adjustment.
2. Open the saw wheel guard (front doors).
3. Make sure the sawblade tension is so proper before adjusting sawblade tracking.
4. Slowly turn the saw wheel by hand, and check the sawblade running track condition.
5. To adjust the sawblade track in rightward/leftward direction on the drive side saw wheel, loosen the fixing nut (2).

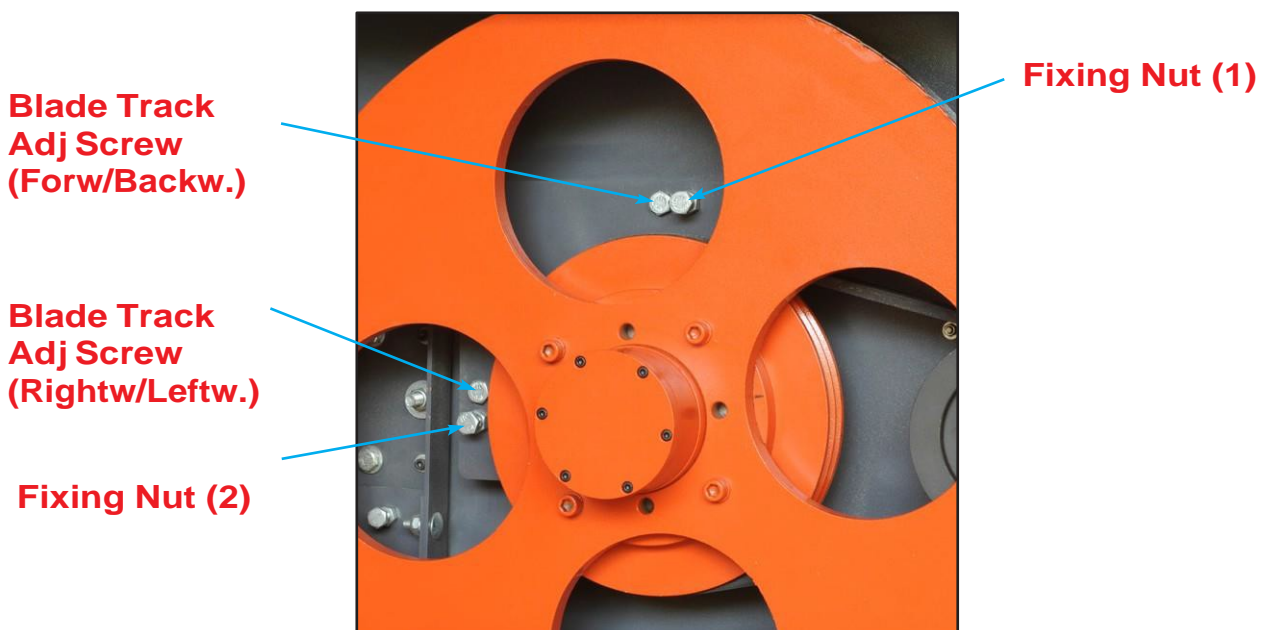

DRIVE SIDE SAW WHEEL

ADJUSTING SAWBLADE TRACK (RIGHTWARD/ LEFTWARD DIRECTION)

6. Turn the blade track adjustment screw 1/4 turn counterclockwise for moving the sawblade leftward. Turn the screw 1/4 turn clockwise for moving the sawblade rightward.
7. After blade track is adjusted, tighten the fixing nut (2).
8. During track adjustment, slowly turn the saw wheel by hand to check if the sawblade runs on the correct track.
9. The sawblade tracking adjustment on the idle side saw wheel is same as that of the drive side saw wheel.

ADJUSTING CONVEYOR BELT TRACKING

1. If the conveyor belt runs to either right or left side, you need to adjust the conveyor belt running track.
2. Before adjusting the conveyor belt tracking, make sure the conveyor belt tension is tightened. Otherwise, you should adjust belt tension before adjusting its running track.
3. Loosen the two lock screws (1) (2). Loosen the nut (3). Tighten the nut (4) until the conveyor belt runs at a proper track.
4. After adjustment, tighten the lock screws (1) (2) and the nut (3).



ADJUSTING THE LOADING PRESSURE OF INFEED PRESSURE ROLLER

The loading (hold-down) pressure and raising sensitivity of the infeed pressure roller can be adjusted by turning the two air flow regulators, provided on the air cylinder located at the infeed end.

The “UPPER AIR FLOW REGULATOR “is used to adjust the hold-down pressure of the infeed pressure roller.

The “LOWER AIR FLOW REGULATOR “is used to adjust the sensitivity of the infeed pressure roller.



CONVENIENT WOOD INFEED

The infeed roller assembly is equipped with a sensing plate. Once the wood touches the sensing plate, the infeed roller assembly will raise slowly. This allows the wood to be pressed by the infeed roller easily without blocking problems.

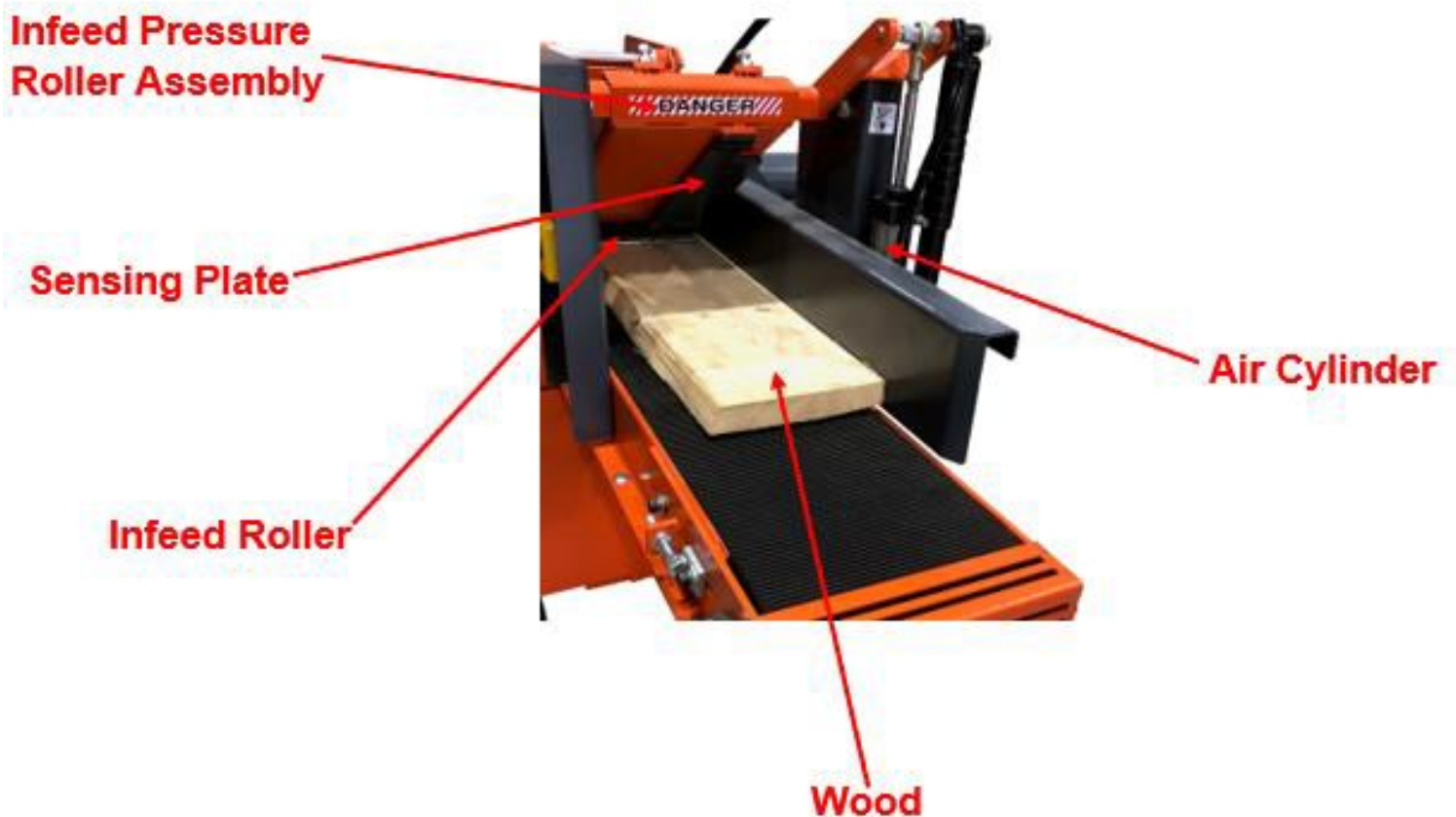

MAINTENANCE

Proper maintenance is important to keep the machine in the best condition. Note that a small problem may lead to poor machine performance or even cause a serious damage. Therefore, the operator and maintenance personnel should not neglect the maintenance work.

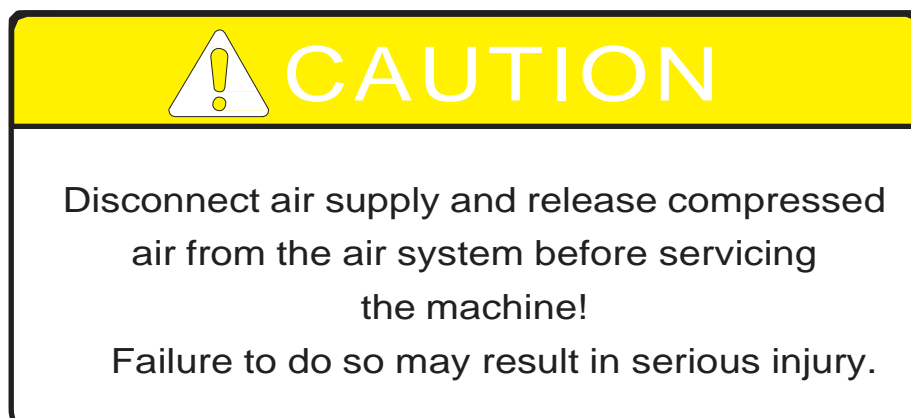

Before performing any maintenance, stored energy such as moving blades, feed system and air pressure shall be dissipated.

Stop the machine by the normal stopping procedure. Wait until all rotating parts are completely stop. Disconnect the power supply.

Release compressed air from the air system.

1. NOTICES FOR GENERAL MAINTENANCE.

- (1) Keep the machine from direct sun light.
- (2) The machine installation location should be dry and well ventilated.
- (3) Do not use poor quality lubrication oil.
- (4) When the job is finished, clean the machine and turn the power off.
- (5) In case abnormal motion occurs, it is necessary to record the malfunction and troubleshooting result.
- (6) It is strongly recommended that only original spare parts be used.

MAINTENANCE

2. DAILY MAINTENANCE

- (1) Every day before starting the machine, check all lubrication positions of the machine.
- (2) Every day when the work is finished, clean the machine. Remove wood chips from the machine and surroundings. Apply oil on the sliding parts. Turn power off.
- (3) During operation, if any abnormal noise occurs, stop machine operation immediately.
- (4) If inaccurate cutting size occurs, stop the machine. Check and make correction.

MAINTENANCE

3. WEEKLY MAINTENANCE

- (1) Clean the filter screen and fan in the electrical cabinet.
- (2) Clean the entire machine and the working area.
- (3) Check if any switch or push-button has loosened or not. If loosened, tighten securely.
- (4) Check if warning devices and proximity sensors work normally or not.
- (5) Open wheel Hubs on Saw Wheel and tighten Bearing retaining nut by one notch, this ensures the bearings are preloaded. **(PLEASE NOTE (5) THIS WILL ONLY BE PERFORMED AFTER THE FIRST WEEK OF OPERATION)**

4. HALF-YEAR MAINTENANCE

- (1) Check if air source pressure is set in the normal range.
- (2) Check home positions of various mechanisms.
- (3) Check positioning accuracy and gear backlash.

5. YEARLY MAINTENANCE

- (1) Inspect machine accuracy. If necessary, make adjustment.
- (2) Inspect leveling accuracy.
- (3) Check if all switches and push-buttons work normally or not.

MAINTENANCE

Safety devices on the HR150 resaw which must be checked before every shift:

- E-STOP button and its circuit inspection
- Up/down limit switches
- Blade cover safety switch and its circuit inspection.

E-STOP button and its circuit inspection

Turn on the blade motor. Press and hold the E-STOP button. The blade and feed motors should be stopped. Pressing the START button should not start the motor until the E-STOP button is released.

With E-STOP button pressed, try to move the saw head up and down (using the switch and the Setworks buttons). Try to start the feed. Up/down and feed systems should not start.

Up/down limit switches

Turn on the blade motor. Try to move the saw head over the maximum saw head height and below the minimum saw head height specified in the “Machine Specification” Section. Saw head should stop when reaching up or down height limit.

Blade cover safety switch and its circuit inspection

Turn on the blade motor. Try to open the blade covers. They should not open.

Stop the blade motor. Open the blade cover. Try to start the blade motor. The motor should not start.

TROUBLE SHOOTING

PROBLEM	PROBABLE CAUSES	CORRECTION
SAWBLADE SLOW DOWN DURING CUTTING	<ol style="list-style-type: none"> 1. Sawblade is dulled 2. Motor overload 3. Sawblade tension is too loose 	<ol style="list-style-type: none"> 1. Sharpen or replace sawblade 2. Reduce cutting speed 3. Tighten sawblade
SAWBLADE BREAK	Too tight tension of sawblade	Adjust sawblade tension properly
SAWBLADE RUNNING TRACK IS IMPROPER	Sawblade running track is not adjusted properly	Adjust sawblade running track
SAWBLADE DULL QUICKLY	Cutting incorrect material	Cutting correct material only.

HYDRAULIC SCHEMATIC

