

Table of contents

Page	Page type	Page description	Date	Edited by
/A1	Table of contents	Table of Contents	1/12/2021	MOC
/B1	Overview	Revision History	1/12/2021	MOC
+L1/1	Schematic multi-line	Power	1/12/2021	MOC
+DOC/C1	Parts list	Parts List	4/22/2020	MOC
+DOC/D1	Terminal line-up diagram	Terminal Lineup Diagram	10/30/2020	MOC
+DOC/E1	Cable overview	Cable Overview	4/22/2020	MOC
+DOC/F1	Graphic	Enclosure Layout	6/1/2020	MOC
+DOC/F2	Graphic	Component Layout	4/22/2020	MOC

**Wood-Mizer**[®]

Project Description: MD400EA3U

Revision: C Pg Desc: Table of Contents

Mounting Location: + Type: Table of contents

Prev. pg: Page: A1 Next pg: B1 Total Pgs: 8

Revision History

Date	Revision	Revision Record	Drawn By	Checked By
4/22/20	A	INITIAL DESIGN	MOC	MOC
	B		MOC	MOC
1/12/21	C	ADDED MOTOR HOOKUP DRAWING	MOC	MOC

		Wood-Mizer®	
Project Description: MD400EA3U			
Revision: C		Pg Desc: Revision History	
Mounting Location: +		Type: Overview	
Prev. pg: A1	Page: B1	Next pg: +L1/1	Total Pgs: 8

Wood-Mizer®

Voltage	240 +5 / -10%
Phase	1Ph
Frequency	60Hz
FLA, Machine	17A
FLA, Largest Load	17A
Wiring Diagram	MD400EA3U
SCCR	50kA

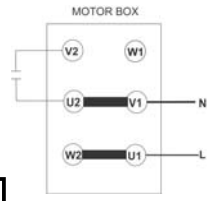
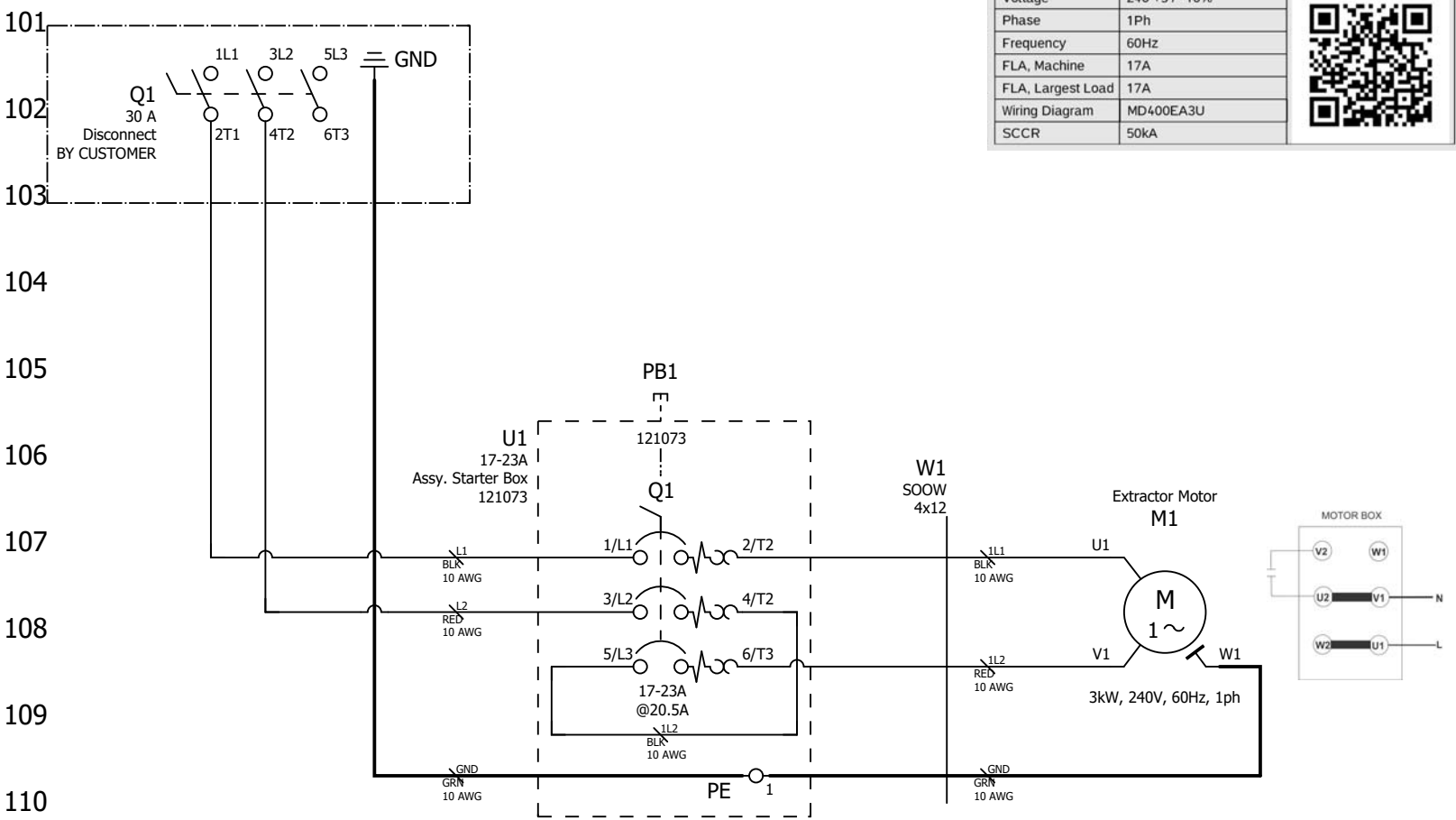
101
102
103
104
105
106
107
108
109
110
111
112
113
114
115
116
117
118
119
120
121

Terminal line-up diagram

Terminal strip +L1-U1-PE								
Terminal				Jumper		End Plate	Remark	Terminal X-Ref
Ref. Des.	Level	P/N	Description	Diagram	P/N	P/N		
1								/1.10



Project Description: MD400EA3U

Revision: C Pg Desc: Terminal Lineup Diagram

Mounting Location: +DOC Type: Terminal line-up diagram

Prev. pg: C1 Page: D1 Next pg: E1 Total Pgs: 8

Cable Overview

Cable Designation	Cable Part Number	Cable Description	Cable X-Ref
W1	121078	Cable Assy, MD400EA3U Motor	+L1/1.107

		Wood-Mizer®	
Project Description: MD400EA3U			
Revision: C		Pg Desc: Cable Overview	
Mounting Location: +DOC		Type: Cable overview	
Prev. pg: D1	Page: E1	Next pg: F1	Total Pgs: 8

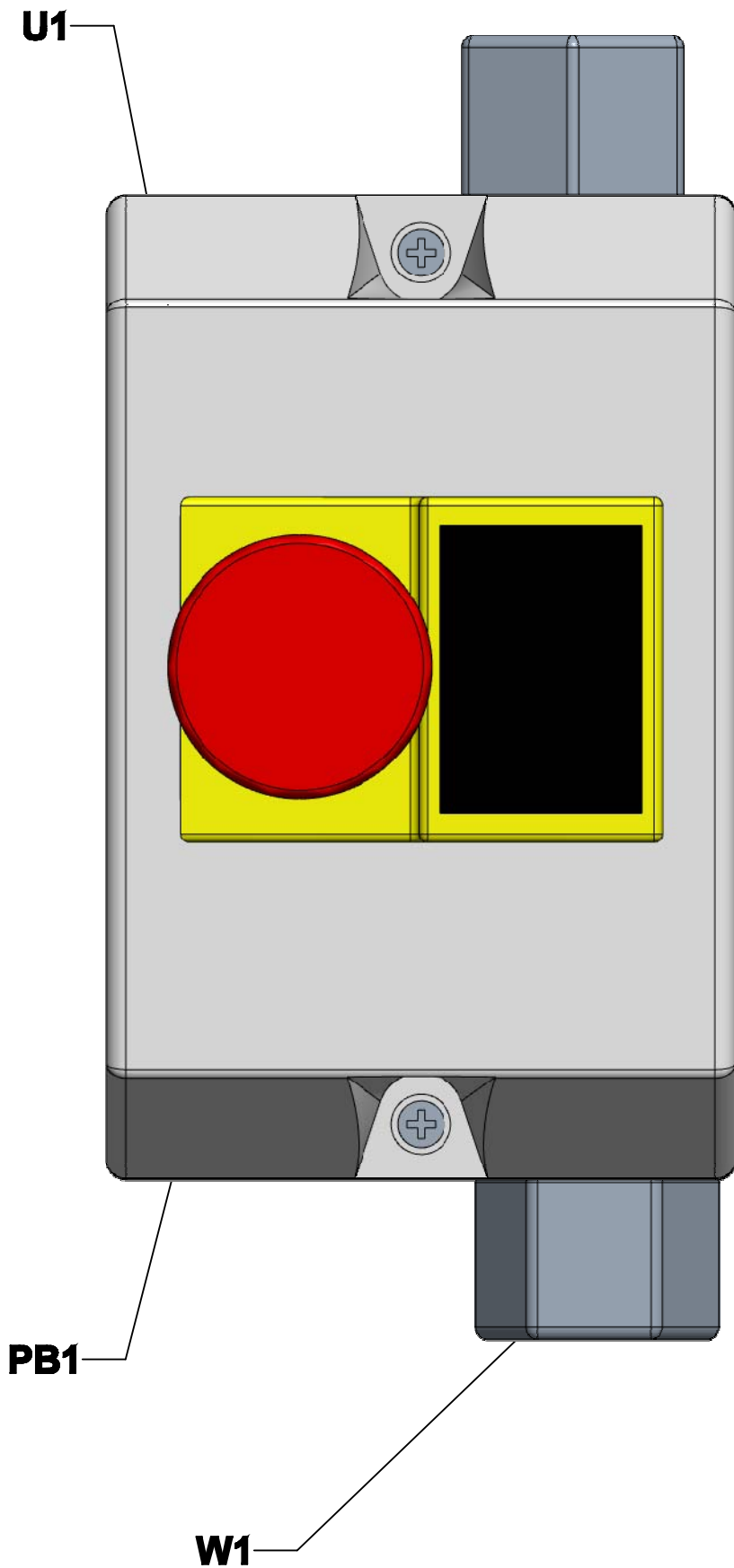

		Wood-Mizer®	
Project Description: MD400EA3U			
Revision: C		Pg Desc: Enclosure Layout	
Mounting Location: +DOC		Type: Graphic	
Prev. pg: E1	Page: F1	Next pg: F2	Total Pgs: 8

U1

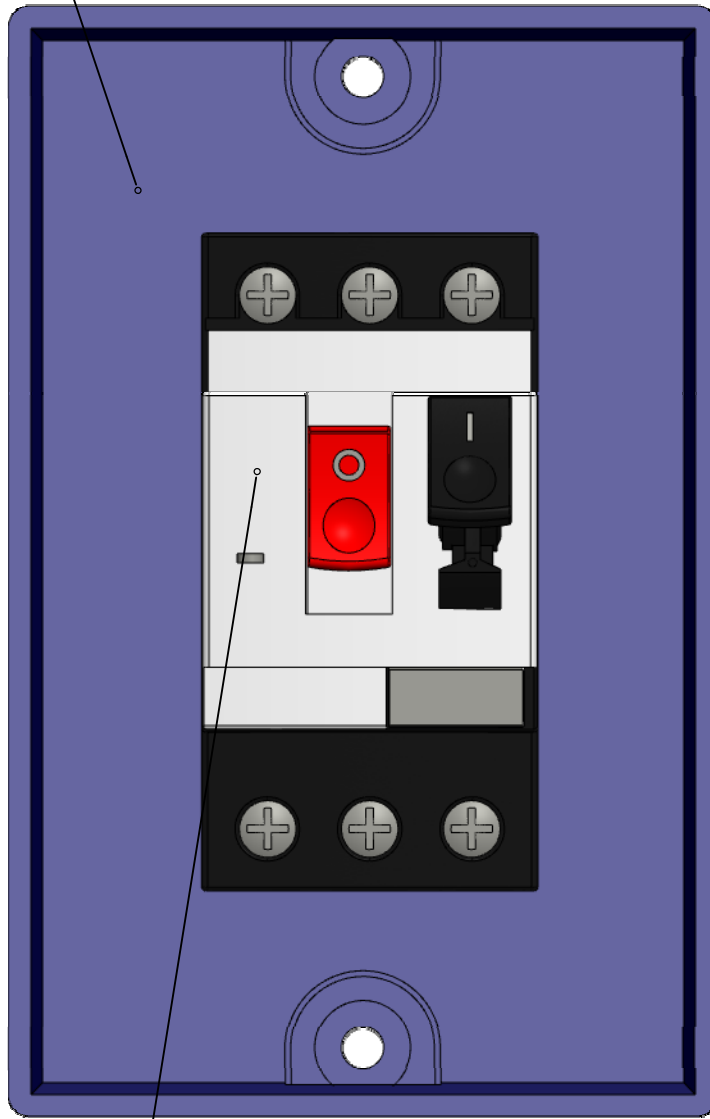

Q1:
Set to 20.5A



Wood-Mizer®

Project Description: MD400EA3U

Revision: C Pg Desc: Component Layout

Mounting Location: +DOC Type: Graphic

Prev. pg: F1 Page: F2 Next pg: Total Pgs: 8