

**Wood-Mizer® Moulder Planer
Safety, Setup, Operation,
and Maintenance**

MP260EA13U-V	rev. B2.00-B2.01
MP260EB13U-V	rev. B2.00-B2.01

Safety is our #1 concern!

Form #2333-US



WARNING! Read and understand this manual before using this machine.

California

Proposition 65 Warning



WARNING: Breathing gas/diesel engine exhaust exposes you to chemicals known to the State of California to cause cancer and birth defects or other reproductive harm.

Always start and operate the engine in a well-ventilated area.
If in an enclosed area, vent the exhaust to the outside.
Do not modify or tamper with the exhaust system.
Do not idle the engine except as necessary.

For more information go to www.P65warnings.ca.gov.



WARNING: Drilling, sawing, sanding or machining wood products can expose you to wood dust, a substance known to the State of California to cause cancer. Avoid inhaling wood dust or use a dust mask or other safeguards for personal protection.

For more information go to www.P65Warnings.ca.gov/wood.

Active Patents assigned to Wood-Mizer, LLC

Wood-Mizer, LLC has received patents that protect our inventions which are a result of a dedication to research, innovation, development, and design. Learn more at: woodmizer.com/patents

©2024 Wood-Mizer LLC

Printed in the United States of America, all rights reserved. No part of this manual may be reproduced in any form by any photographic, electronic, mechanical or other means or used in any information storage and retrieval system without written permission from

Wood-Mizer, LLC
8180 West 10th Street
Indianapolis, Indiana 46214

SECTION 1 INTRODUCTION

1.1	About This Manual	1-2
1.2	Getting Service.....	1-2
1.3	Specifications	1-2
1.4	Options and Accessories	1-2

SECTION 2 GENERAL SAFETY

2.1	Safety Symbols	2-1
2.2	Safety Instructions.....	2-1
2.3	Electrical Lockout Procedures	2-2

SECTION 3 SETUP

3.1	Site preparation	3-1
3.2	Uncrate and Assemble	3-2
3.3	Checking rotation direction.....	3-5
3.4	Setup of upper and lower cutter heads	3-5
3.5	Side cutter setup	3-12
3.6	Feed rollers.....	3-15
3.7	Leveling the machine table	3-16
3.8	Running the first test board.....	3-17

SECTION 4 OPERATION

4.1	Operation.....	4-1
4.2	Planing tips.....	4-2

SECTION 5 MAINTENANCE

5.1	Overview	5-1
5.2	Workspace Tips.....	5-1
5.3	During use	5-1
5.4	After each use	5-1
5.5	Lubrication points	5-2
5.6	Cleaning the metal feed rollers	5-4
5.7	Table lift assist chain adjustments	5-5
5.8	Replacing feed chain gear sprocket set screw.....	5-5
5.9	Removing and replacing feed chains	5-6
5.10	Replacing Belts	5-7
5.11	Sharpening Knives	5-9

SECTION 6 TROUBLESHOOTING

6.1	Mechanical or electrical problems	6-2
-----	---	-----

Wood-Mizer® LLC Limited Product Warranty



Wood-Mizer LLC ("Warrantor"), an Indiana corporation with its principal place of business at 8180 West Tenth Street, Indianapolis, IN 46214-2400 USA, warrants to the purchaser ("Purchaser") that for the time periods specifically stated herein and subject to the terms, conditions and limitations stated herein, the equipment manufactured by the Warrantor will be free from defects in material and workmanship attributable to Warrantor so long as, during the warranty periods stated herein, the equipment is installed, operated and maintained in accordance with the instructions provided by Warrantor.

PRODUCT	MODEL CLASS	LENGTH OF WARRANTY		EFFECTIVE DATE
		USA & CANADA	NON USA & CANADA	
Portable Sawmills, Resaws, Edgers	LT, LX, HR, EG	Two years	One year	Date of purchase
Portable Sawmills with Chassis	LT28, LT35, LT40, LT50, LT70, LX450	Two years, excluding the chassis, which chassis shall have a five year warranty	One year	
Industrial Sawmills, Resaws, Edgers	WM, HR, EG, TVS, SVS	One year	One year	Date of purchase or date of installation / training (if applicable), whichever occurs first, not to exceed 6 months from date of purchase
TITAN Industrial	WB, TV, HR, EG, EA, MR	One year	One year	
Material Handling	TWC, IC, TD, LD, GC, CR, CB, CC	One year	One year	
Blade Maintenance Equipment	BMS, BMT, BMST	One year	One year	Date of purchase
Options and Accessories	Various	One year*	One year*	
Moulders, Extractors	MP, MD	Two years	One year	
Kilns	KS, KD	One year	One year	
Slab Flatteners	MB	Two years	One year	
Pallet Equipment	PD, PC	One year	One year	
Log Splitters	FS	One year	One year	
Replacement Parts	Various	90 days	90 days	

* Warranty on Options will match the warranty on the primary equipment when purchased on same invoice.

Exclusions from 90 Day, Limited One Year and Two Year Warranty

Warrantor shall have no responsibility under this warranty for any wear components, including, but not limited to: belts, blade guides, blades, electric motor brushes, drum switches, filters, fuses, hoses, bearings (excluding cylindrical drive bearings), bushings, cable carriers, and spark plugs. All wear components are furnished "as is", without any warranty from Warrantor. This limited warranty does not cover any defects caused by misuse, negligence, alterations, damage due to overload, abnormal conditions, excessive operation, accident, or lack of performance of normal maintenance services.

Several components which are used in the manufacture of the equipment but not manufactured by Warrantor such as cant hooks, power plants, laser sights, batteries, tires, and trailer axles have warranties provided by the original equipment manufacturer (written copies available upon request). Warrantor does not separately warrant such items. Components or equipment manufactured by third parties are not covered by this warranty. Warrantor, however, will provide reasonable assistance to the Purchaser to make claims against any warranties applicable to such component parts as provided by such original equipment manufacturers. Components or equipment manufactured by third parties are not covered by this Warranty.

Five Year Limited Chassis Warranty

The limited five year chassis warranty described above, DOES NOT extend to (a) any damage stemming from accident, improper towing, overload, abuse, misuse, abnormal conditions, negligence, excessive operation, or lack of maintenance, (b) rust caused by exposure to corrosive atmospheric conditions, or (c) the sawmill head, carriage, axle, brakes, or any hydraulic or electrical components attached to the chassis.

Warrantor's Obligations as To Defects

In the event that the equipment fails to perform due to defective materials or workmanship attributable to Warrantor under normal use and service within the established warranty period, Purchaser's sole and exclusive remedy and Warrantor's sole liability shall be to replace or repair, in Warrantor's sole and subjective discretion, any defective part at Warrantor's principal place of business without cost to the Purchaser if such defect exists. The determination of whether a product is defective shall be made by Warrantor in Warrantor's sole and subjective discretion. The Purchaser must notify Warrantor prior to shipping any defective part. Warrantor, at its sole discretion, may cover expenses incurred in shipping the defective part to Warrantor for evaluation; provided, however, that Warrantor will not be responsible for labor, travel time, mileage, removal, installation or incidental or consequential damages. However, any part in excess of 140 pounds must be returned by the Purchaser, to the Warrantor's nearest authorized facility at the Purchaser's expense, if return is requested by Warrantor. Warrantor shall have a reasonable time within which to replace or repair the defective part. If Warrantor determines that the product is not defective under the terms of this warranty in Warrantor's sole and subjective discretion, then Purchaser shall be responsible for any expenses incurred by Warrantor in returning the equipment to the Purchaser.

Limitations and Disclaimers of Other Warranties

EXCEPT FOR THE EXPRESS WARRANTY PROVISIONS STATED ABOVE, WARRANTOR DISCLAIMS ALL WARRANTIES, EXPRESS AND/OR IMPLIED, INCLUDING WITHOUT LIMITATION, THE IMPLIED WARRANTIES OF MERCHANTABILITY, AND FITNESS FOR A PARTICULAR PURPOSE, NON-INFRINGEMENT AND TITLE. No representation or other affirmation of fact by representatives of Warrantor, whether verbal or in writing, including photographs, brochures, samples, models, or other sales aids, shall constitute a warranty or other basis for any legal action against Warrantor. There are no other representations, promises, agreements, covenants, warranties, guarantees, stipulations or conditions, express or implied, by Warrantor except as expressly set forth herein. THE ORIGINAL PURCHASER AND ANY INTENDED USER OR BENEFICIARY OF THIS EQUIPMENT, SHALL NOT BE ENTITLED TO RECOVER ANY INDIRECT, SPECIAL, PUNITIVE, EXEMPLARY, CONSEQUENTIAL, SPECIAL, OR INCIDENTAL DAMAGES OR LOSSES, INCLUDING BUT NOT LIMITED TO, DAMAGES OF LOST PRODUCTION, LOST REVENUE, LOST PRODUCT, LOST PROFITS, LOST BUSINESS, LOSS OF USE, LOSS OF GOODWILL, OR BUSINESS INTERRUPTION, FROM WARRANTOR FOR ANY REASON WHATSOEVER INCLUDING WITHOUT LIMITATION WARRANTY OR DEFECT IN THE PRODUCT REGARDLESS OF THE SOLE, JOINT AND/OR CONCURRENT NEGLIGENCE, BREACH OF CONTRACT, BREACH OF WARRANTY, STRICT LIABILITY IN TORT OR STATUTORY CLAIMS OR OTHER LEGAL FAULT OR RESPONSIBILITY OF EITHER WARRANTOR OR PURCHASER OR ITS EMPLOYEES OR AGENTS. Warrantor does not warrant that its equipment meets or complies with the requirements of any particular safety code or governmental requirements.

Defective items replaced under the terms of this warranty become the property of Warrantor.

Design Changes

Warrantor reserves the right to change the design of its products from time to time without notice and without obligation to make corresponding changes in or to its products previously manufactured.

Rights of Purchasers

The validity and effect of this limited warranty as well as its interpretation, operation and effect, shall be determined exclusively by the principles of law and equity of the State of Indiana, USA. This limited warranty gives Purchaser specific legal rights. Purchaser may also have other rights, which may vary from state to state. Some states may not allow limitations as to the duration of implied warranties or to the exclusion or limitation of incidental or consequential damages, so some of the limitations and exclusions detailed set forth above may not apply. In the event that any one or more of the provisions of this warranty shall be or become invalid, illegal or unenforceable in any respect, the validity, legality and enforceability of the remaining provisions of this warranty shall not be affected thereby.

Interpretations

This Warranty constitutes the entire warranty agreement between Warrantor and Purchaser and supersedes any prior understandings or agreements pertaining to the same subject matter. This warranty cannot be amended except in writing which refers to this warranty which is signed by both Warrantor and Purchaser.

SECTION 1 INTRODUCTION

1.1 About This Manual

This manual replaces any previous information received on your Wood-Mizer® equipment.

The information and instructions in this manual do not amend or extend the limited warranties for the equipment given at the time of purchase.

1.2 Getting Service

For contact information, sales, service, parts, and additional manuals, sign into your account on <https://woodmizer.com>, or call inside the USA: 1-800-553-0182 or from outside the USA: 317-271-1542

1.3 Specifications

Equipment specification are included in the Online Manuals, which are found at <https://apps.woodmizer.com/Manuals/Manuals.aspx?parent=0>.

1.4 Options and Accessories

Your Wood-Mizer product may have options that can be added to the machine or accessories available to purchase. Different power configurations are also available.

Option: Your specific product can have accessories installed at the factory, or installed in the field. For example, a sawmill might have a debarker or power-feed option.

Accessory: Your specific product may have accessories added to the machine that are not available to be installed at the factory. They may only be installed in the field. For example, a sawmill might have a bed extension or a Shingle/Lap Sider accessory.

Power Options: Your specific product power option is detailed based on the specific product number purchased.

This product has the following options available:

Document	Name	Type
2358	Chip Extractor	Accessory
2459	Extension Tables	Accessory
See website	Planing and moulding knives	Option
N/A	Rubber feet rollers (Castors)	Option/Accessory

FIG. 1-1

SECTION 2 GENERAL SAFETY

2.1 Safety Symbols

The following symbols and signal words call your attention to instructions concerning your personal safety. Be sure to observe and follow these instructions.

 **DANGER!** indicates an imminently hazardous situation which, if not avoided, will result in serious injury or death.

 **WARNING!** suggests a potentially hazardous situation which, if not avoided, could result in serious injury or death.

 **CAUTION!** refers to potentially hazardous situations which, if not avoided, may result in minor or moderate injury or damage to equipment.

NOTICE indicates vital information.

2.2 Safety Instructions

OWNER/OPERATOR'S RESPONSIBILITY

The procedures listed in this manual may not include all ANSI, OSHA, or locally required safety procedures. **It is the owner/operator's responsibility and not Wood-Mizer LLC to ensure all operators are properly trained and informed of all safety protocols.** Owner/Operators are responsible for following all safety procedures when operating and performing maintenance to the equipment.

Observe ALL Safety Instructions

NOTICE Read the entire Operator's Manual before operating this equipment.

Note all safety warnings throughout this manual and those posted on the machine.

Be able to access this manual at all times while operating this equipment.

Read additional manufacturer's manuals and observe their applicable safety instructions.

Only persons who have read and understood the entire operator's manual should operate this equipment.

This equipment is not intended for use by or around children.

It is the owner/operator's responsibility to comply with all applicable federal, state, and local laws, rules, and regulations regarding the ownership, operation, and transporting your equipment.



Operators should become thoroughly familiar with and comply with these applicable laws for operating and transporting equipment.

WEAR SAFETY CLOTHING

 **WARNING!** Secure all loose clothing and jewelry before operating the Planer Moulder.

Always wear eye, ear, and foot protection when operating the Planer Moulder.



Wear hand protection while servicing the Planer Moulder knives.

PLANER MOULDER SETUP

 **DANGER!** Do not operate the Planer Moulder without all covers and guards in place.

 **WARNING!** Set up the planer moulder on solid, level ground.

Do not stand in line with the workpiece when it is being fed into the machine; boards (kickbacks) or other objects may be thrown from the machine.

KEEP HANDS AWAY

 **DANGER!** Remove power before clearing debris or any other maintenance activity.

Never place your hands or tools above or beneath the machine table while the machine is running.

 **WARNING!** Avoid contact with any hot parts (motors).

Allow the system to cool sufficiently before beginning any service function, including debris removal.

Avoid contact with sharp edges of the cutting knives.

KEEP PLANER MOULDER AND AREA AROUND PLANER MOULDER CLEAN

 **WARNING!** Maintain a clean and clear path for all necessary movement around the Planer Moulder and material stacking areas.

Do not allow children in the area of the Planer Moulder. Failure to follow this may result in death or serious injury

DISPOSE OF WOOD BY-PRODUCTS PROPERLY

NOTICE Properly dispose of all wood by-products, including sawdust, chips, and other debris, including operation waste such as oil, filters, etc.

KEEP SAFETY LABELS IN GOOD CONDITION

NOTICE Ensure that all safety decals are clean and readable. Replace all damaged safety decals to prevent personal injury or damage to the equipment. Contact your local distributor, or call your Customer Service Representative to order more decals.

NOTICE If replacing a component that has a safety decal affixed to it, ensure the new component also has the safety decal affixed.

2.3 Electrical Lockout Procedures

RULES FOR USING LOCKOUT PROCEDURE

The equipment shall be locked out to protect against accidental or inadvertent operation when such operation could cause injury to personnel. Do not attempt to operate any switch or valve bearing a lock.

LOCKOUT PROCEDURES MUST BE USED DURING, BUT NOT LIMITED TO:

- Changing or adjusting blades
- Unjamming operations
- Cleaning
- Mechanical repair
- Electrical maintenance
- Retrieval of tools/parts from work area
- Activities where guards or electrical panel guard is open or removed

MAINTENANCE HAZARDS INCLUDE, BUT NOT LIMITED TO:

- Blade contact
- Pinch points
- Kickbacks
- Missiles (thrown blades/wood chips)
- Electrical

FAILURE TO LOCKOUT MAY RESULT IN, BUT NOT LIMITED TO:

- Cut
- Crush
- Blindness
- Puncture
- Electrocutation
- Serious injury and death
- Amputation
- Burn
- Shock

TO CONTROL MAINTENANCE DANGERS:

- Lockout procedures must be followed (see **OSHA regulation 1910.147**).
- Never rely on machine stop control for maintenance safety (emergency stops, on/off buttons, interlocks).
- Do not reach into moving blades or feed systems. Allow all coasting parts to come to a complete stop.
- Electrical power supply and air supply must both be locked out.
- Where established lockout procedures cannot be used (electrical troubleshooting or mechanical dynamic troubleshooting), alternative effective protective techniques shall be employed which may require special skills and planning.
- Always follow safe operations practices in the workplace.

EQUIPMENT LOCKOUT PROCEDURE

Lockout procedures per OSHA regulation 1910.147, appendix A:

GENERAL

The following simple lockout procedure is provided to assist owner/operators in developing their procedures so they meet the requirements of **OSHA regulation 1910.147**. When the energy isolating devices are not lockable, tagout may be used, provided the owner/operator complies with the provisions of the standard which require additional training and more rigorous periodic inspections. When tagout is used and the energy isolating devices are lockable, the owner/operator must provide full operator protection (see OSHA regulation 1910.147, paragraph (c)(3)) and additional training and more rigorous periodic inspections are required. For more complex systems, more comprehensive procedures may need to be developed, documented, and utilized.

PURPOSE

This procedure establishes the minimum requirements for the lockout of energy isolating devices whenever maintenance or servicing is done on machines or equipment. It shall be used to ensure that the machine or equipment is stopped, isolated from all potentially hazardous energy sources and locked out before personnel perform any servicing or maintenance where the unexpected energization or start-up of the machine or equipment or release of stored energy could cause injury.

COMPLIANCE WITH THIS PROGRAM

All personnel are required to comply with the restrictions and limitations imposed upon them during the use of lockout. The authorized personnel are required to perform the lockout in accordance with this procedure. All operators, upon observing a machine or piece of equipment which is locked out to perform servicing or maintenance shall not attempt to start, energize, or use that machine or equipment.

SEQUENCE OF LOCKOUT

1. Notify all affected personnel that servicing or maintenance is required on a machine or equipment and that the machine or equipment must be shut down and locked out to perform the servicing or maintenance.
2. The authorized employee shall refer to the company procedure to identify the type and magnitude of the energy that the machine or equipment utilizes, shall understand the hazards of the energy, and shall know the methods to control the energy.
3. If the machine or equipment is operating, shut it down by the normal stopping procedure (depress the stop button, open switch, close valve, etc.).
4. De-activate the energy isolating device(s) so that the machine or equipment is isolated from the energy source(s).
5. Lock out the energy isolating device(s) with assigned individual lock(s).
6. Stored or residual energy (such as that in capacitors, springs, elevated machine members, rotating flywheels, hydraulic systems, and air, gas, steam, or water pressure, etc.) must be dissipated or restrained by methods such as grounding, repositioning, blocking, bleeding down, etc.
7. Ensure that the equipment is disconnected from the energy source(s) by first checking that no personnel are exposed, then verify the isolation of the equipment by operating the push button or other normal operating control(s) or by testing to make certain the equipment will not operate.



CAUTION! Return operating control(s) to neutral or "off" position after verifying the isolation of the equipment.

8. The machine or equipment is now locked out.

RESTORING EQUIPMENT TO SERVICE

When the servicing or maintenance is completed and the machine or equipment is ready to return to normal operating condition, the following steps shall be taken.

1. Check the machine or equipment and the immediate area around the machine to ensure that nonessential items have been removed and that the machine or equipment components are operationally intact.
2. Check the work area to ensure that all personnel have been safely positioned or removed from the area.
3. Verify that the controls are in neutral.
4. Remove the lockout devices and re-energize the machine or equipment.

NOTE: The removal of some forms of blocking may require re-energization of the machine before safe removal.

5. Notify affected personnel that the servicing or maintenance is completed and the machine or equipment is ready for use.

PROCEDURE INVOLVING MORE THAN ONE PERSON

In the preceding steps, if more than one individual is required to lock out the equipment, **each shall place his own personal lock on the energy isolating devices.**

SECTION 3 SETUP

3.1 Site preparation



DANGER! Have a certified electrician install the power to your machine.



WARNING! Be sure the power supply cables are not a trip hazard.



CAUTION! Improper voltage will cause damage to the motors and electronic components.

NOTICE The power supply must meet the motor specifications concerning wire size, fused disconnect, and voltage, which are provided in the motor's manual.

The electrical installation must meet local codes.

Locate the MP260 in a dry work area on a firm, level surface.

Ensure proper lighting is available, with attention to extra lighting directly over the planer moulder.

Allow room for the longest piece of material to run through and exit the machine with ease of movement.

Allow space for storing and handling the material that will be running through your planer.

Do not use in temperatures below freezing [32°F (0°C)].

Do not allow the power cables or chip collection hoses to become trip hazards. Plan the routes carefully.

For mounting, you can either bolt the planer moulder to the floor in place with 8 10mm bolts (recommended) or mount the planer moulder on optional locking casters (part # 535166) for ease of moving.

NOTICE Only use casters that are approved for this model.

NOTE: If a caster set is fitted to the machine, ensure the floor is flat and level. Make reliable barriers between the machine and differences in floor level or inclined floor surfaces to prevent the machine from accidentally moving due to gravity.

The safety distance for persons other than the operator is 10 ft (3 m) from the sides of the machine or 26 ft (8 m) from the in- and outfeed sides during operation. Use visual demarcation so that no one can unintentionally come within the risk area.

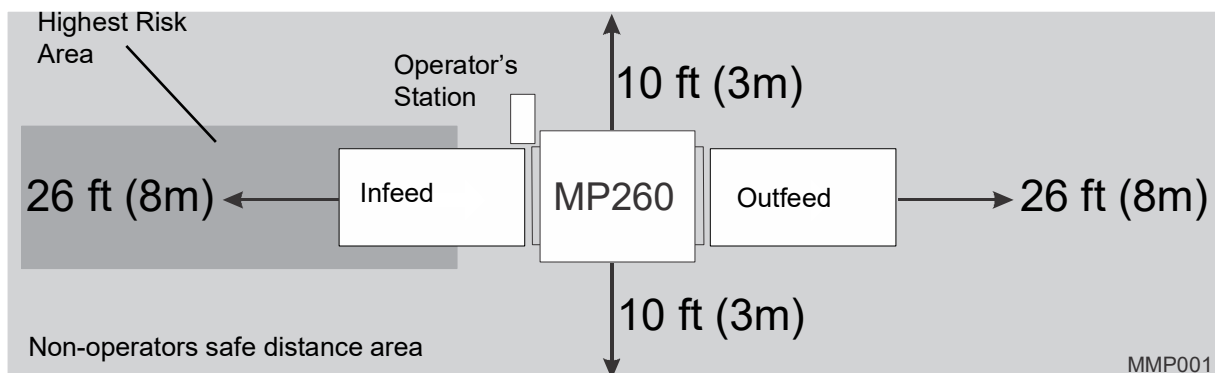

FIG. 3-1

Onsite setup



WARNING! Maintain a clean and clear path for all necessary movement around the planer moulder and material stacking areas.

Keep all hoses, cables, or wire out of the walkway.

Do not allow children in the area of the planer moulder.

Set up the planer moulder on firm, level ground.

Chip collection

The MP260 has 4 chip collection ports--one 5" and three 4" ports--sized to fit flexible hose, one located at each cutter head. A strong vacuum or chip collection system rate approximately 2400 CFM(4000 m³/hr) is recommended for use on standard materials less than 4" thick. For thicker material or extra-wide planks, size your collection system accordingly. Wood-Mizer sells the MD400 chip extraction unit specially made for this model.

When using a collection system, keep in mind:

- Check your local waste disposal codes before designing your chip collection system.
- Design access to your chip collection bins so that they can be easily emptied.
- Short hose runs and smooth-walled hoses reduce suction loss within the system.
- Locate the chip collector controls near the planer moulder controls.
- Collection systems are loud; use ear protection.
- If you are operating this machine in a climate-controlled building and blowing the chips outside, the vacuum created by the chip collector can quickly empty your building of its heated or cooled air.
- If blowing the chips to an indoor bin, an air filter will be necessary to prevent wood dust from reducing the air quality inside of your building.
- If selling chips for use with livestock, do not use harsh chemicals for cleaning or lubricating machinery.

3.2 Uncrate and Assemble

Check your planer/moulder as soon as you receive it. Report any transport damage to the transport company immediately.

Lift the planer/moulder using a forklift or pallet jack with lifting capacity of minimum 1350lbs (~600kg).

Feed tables (optional)

The in- and out-feed tables are both mounted the same way.

NOTE: This kit is used with other moulder models. Not all the parts included in this kit will be used.

1. Install the mounting bracket onto the MP260 base table with the M8 bolts and washers; adjust the bracket in the slotted holes to mount flush with the vertical surface of the MP260 table. See FIG. 3-2 .

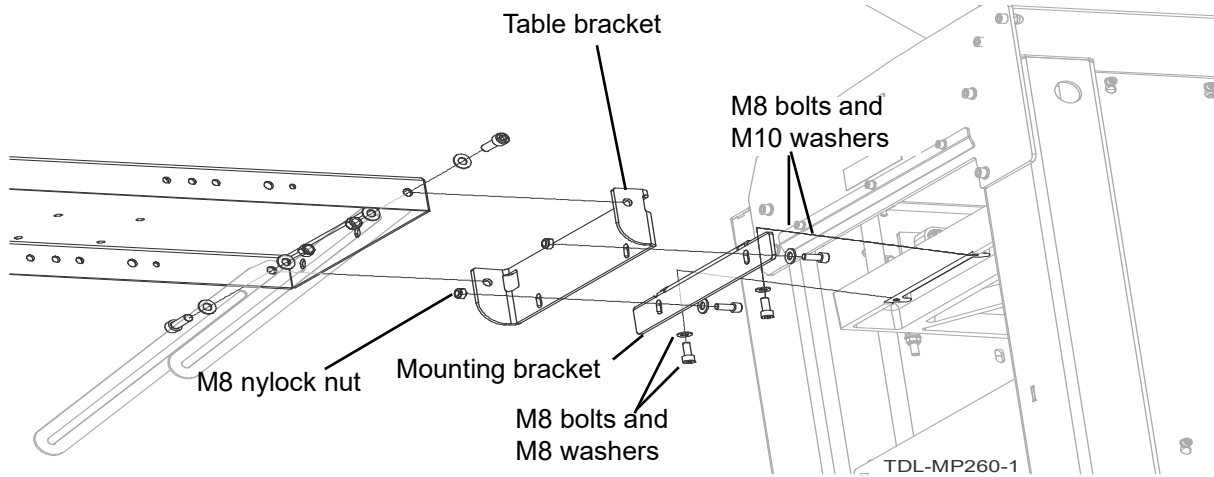

FIG. 3-2

2. Install the table bracket to the mounting bracket with the M8 and M10 washers and M8 nuts; adjust the bracket in the slotted holes to mount flush with the horizontal surface of the MP260 table.
3. Inspect the lower bracket for proper orientation.

NOTE: The lower bracket is used with the MP200 in a different orientation. Ensure the markings of “MP260: This Side Up” are in the proper orientation. See FIG. 3-3.

4. Remove two M6 panel screws and washers at the lower end of the side panel.

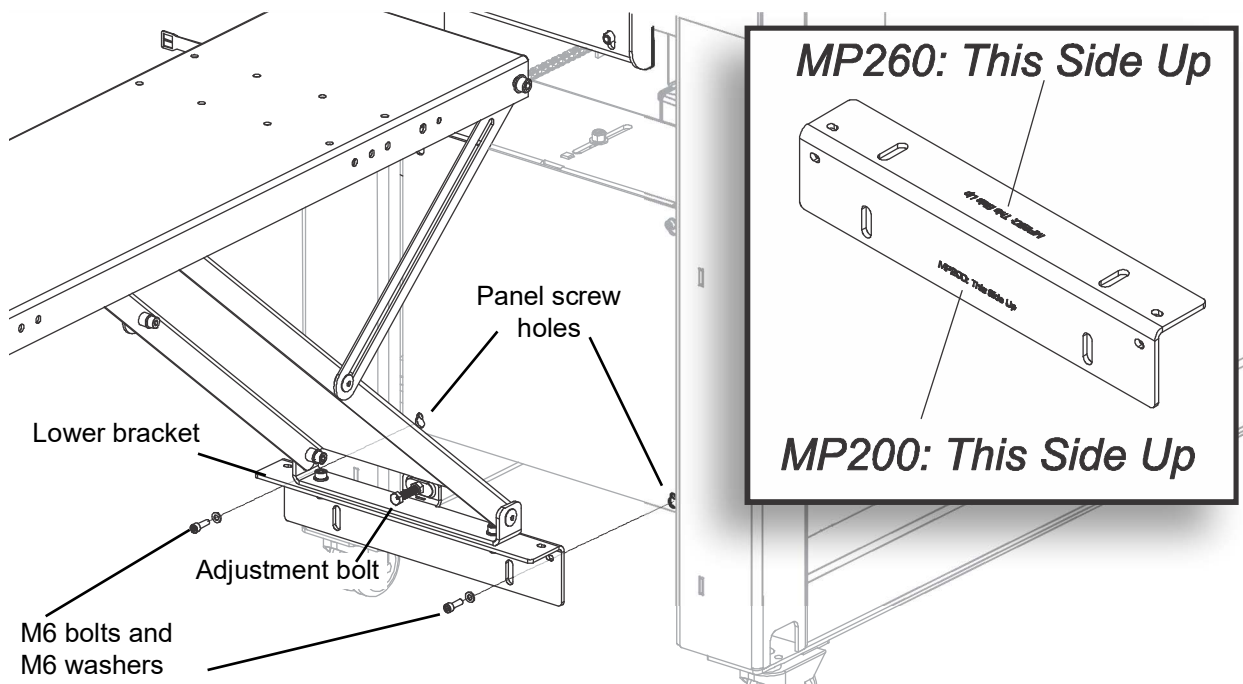

FIG. 3-3

5. Secure the lower bracket with the panel screws and washers. See FIG. 3-3.
6. Place a long straight edge (board, 4' level, etc.) on the feed table to show levelness.
7. Use the adjustment bolt and the screws in the slotted holes in brackets as necessary to level the table with the straight edge/base unit's table.
8. Using the adjusting screws to level the table. and on the same height as the moulder cast iron table (double check this with a long, straight tube or flat board).
9. Tighten all bolts and re-check the table level and height.
10. Repeat all above steps for the outfeed table.

NOTE: The in-feed table must be re-adjusted when the cutting depth of the lower cutter has been changed by adding or removing adjusting plates.

The outer ends of the feed table should never be lower than the machine table.

TIP: With some workpieces, such as thin or soft wood, raise the outer ends of the feed tables slightly higher (0.04-0.4" (1-10 mm)) than the base table to reduce in- and out-feed snipes.

Electrical

Depending on your model, the MP260 planer runs on:

MP260EB	230V 3Ph	50A service	40A, D Curve CB
MP260EA	230V 1Ph	70A service	70A, D Curve CB

The planer normally draws between 18 and 32 amps during operation.

NOTE: If using a 3-phase converter for with installation, size it for a 45 HP load.

Phase converter rating should be a **minimum** of 2 times the total HP load of all machines attached.



WARNING! Have a certified electrician install the power to your machine.

The electric supply is routed into the electrical breaker box on the back of the MP260. This box has a protective cover, and inside there are four 3-pole 16-amp circuit breakers, one for each motor. Each one of the circuit breakers is shared between one motor and the small feed motor.

1. Attach three voltage leads to L1, L2, and L3.
2. Route the four wires (three power, one ground) through the access hole located on the side of the box.
3. Route the ground wire to the green ground bar found in the electric breaker box.

Route the four wires (three power, one ground) through the access hole located on the side of the box.

3.3 Checking rotation direction

1. Turn the Main Power to On; check that the Power On Indicator lights. See FIG. 3-4 .
2. Start **only** the **feed motor (button 5)** on the planer.

 **CAUTION!** Do not start cutter motors before motor rotation direction is checked!

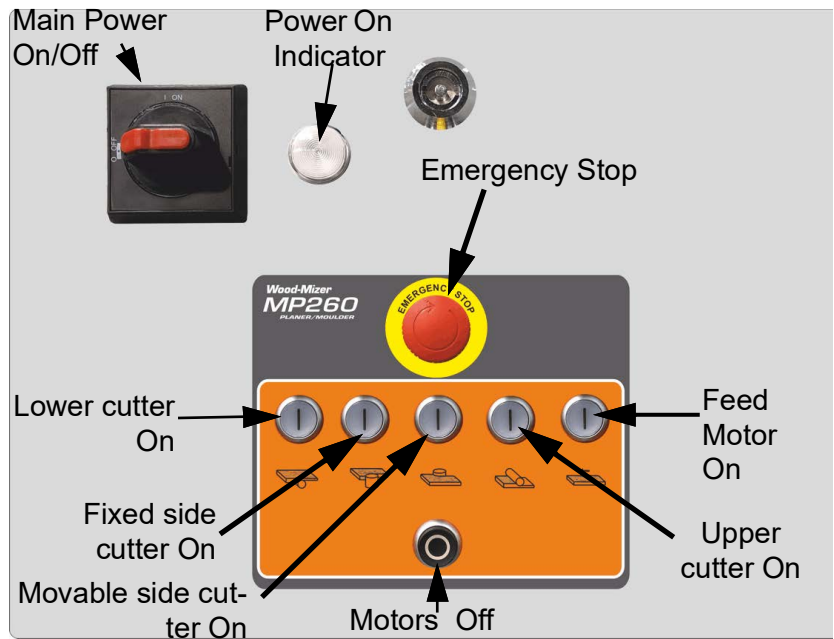

FIG. 3-4

3. Check the rotation of the rollers.
 - If the direction is wrong
 - a. Turn off the main power,
 - b. lock out the system,
 - c. and reverse two of the three supply voltage leads.
4. Turn power back on and check rotation direction again.

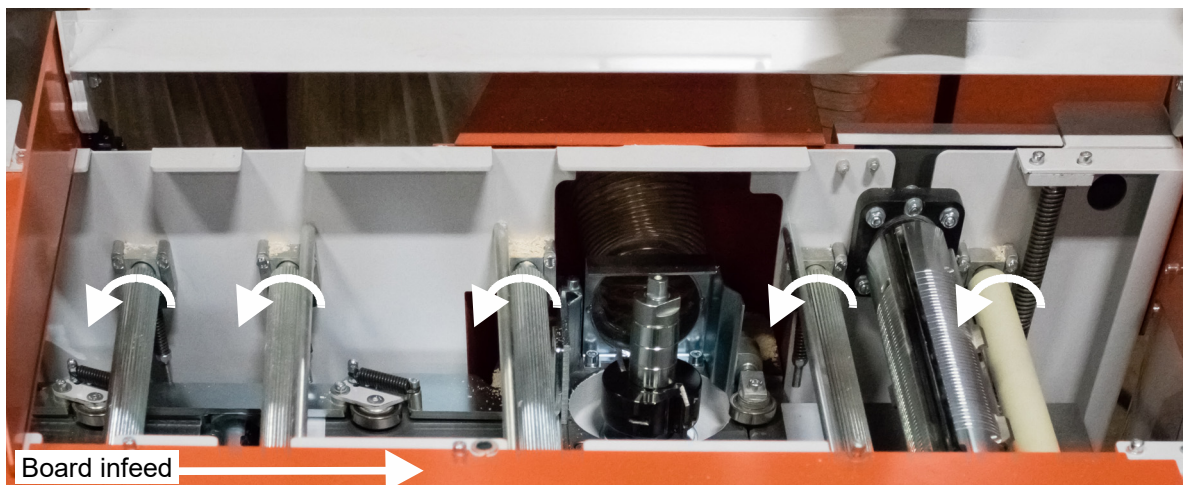



FIG. 3-5

3.4 Setup of upper and lower cutter heads

 **WARNING!** Before adjusting the knives on this machine always turn off the electrical circuit supplying power to the machine.

Wear gloves when working with knives in the machine.

Check for tools used in the operation and remove from the machine before closing the lid.



CAUTION! Check for free rotation of cutter heads before closing the lid.

The cutter heads come shipped with two straight planer knives pre-installed. Check these knives to ensure that the factory settings have not been altered during shipping.

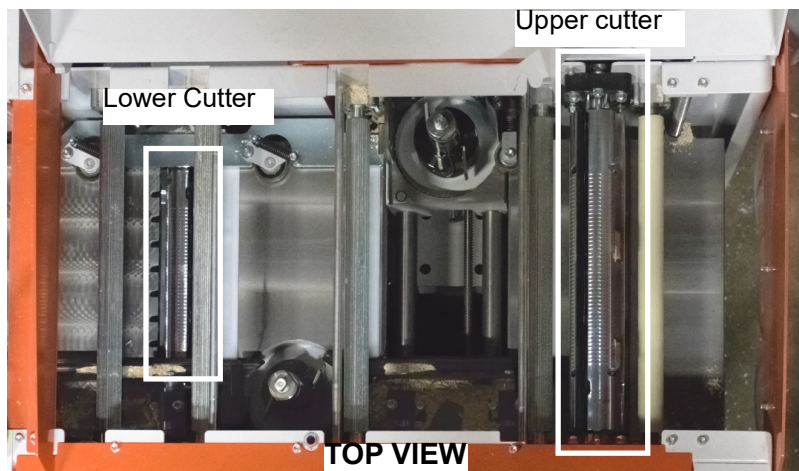

FIG. 3-6

UPPER/LOWER CUTTER DESIGN

The cutter heads are shipped with straight planer knives installed in two of the knife slots. The head can be fitted with 2 additional straight planer knives or moulding knives in the two empty slots

Lower Cutter

Diameter: 2 13/16" (72mm)

Width: 11 13/16" (300mm)

Rotation Speed: 7200 rpm

4 slots for planer knives

Planing Depth: 0 - 5/32"
(0-4mm)

Upper cutter

Diameter: 2 13/16" (72mm)

Width: 16 3/16" (410mm)

Rotation Speed: 7200 rpm

4 slots for planer knives

Planing Depth: Max 5/16" (8mm)
Moulding Depth: Max. 3/4"
(20mm)

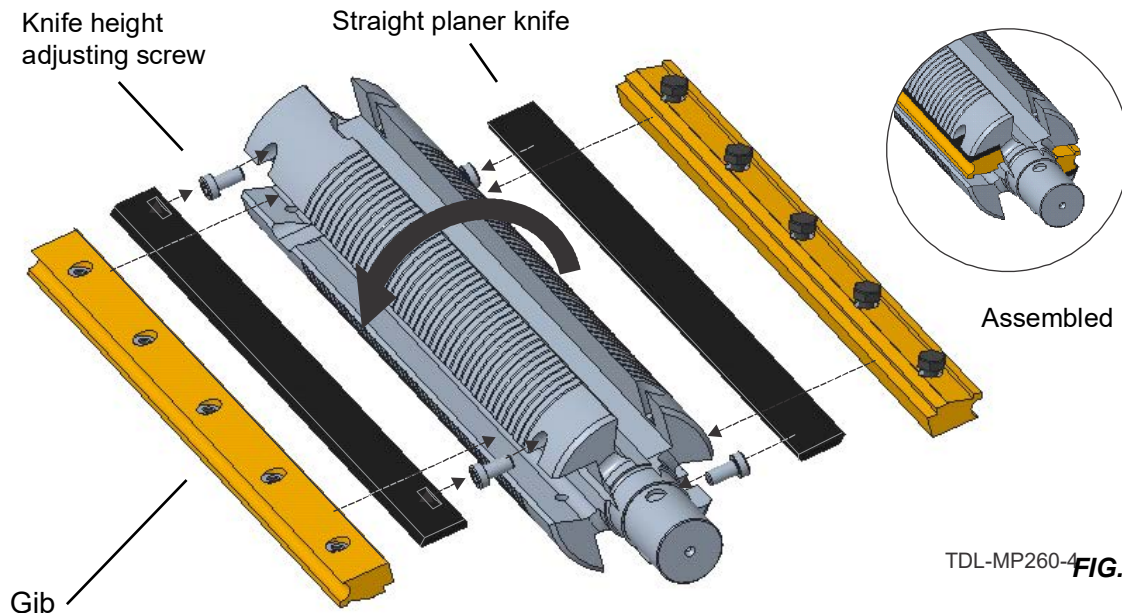
TDL-MP260-4 **FIG. 3-7**

Gib

NOTE: This item often goes by many names - wedge, chip breaker, block, knife lock bar, clamp, or gib. For this manual, it will be referred to as “**gib**.”

Leveling lower cutter straight planer knives

TOOLS NEEDED:

- 10 mm open-end wrench (supplied)
- 4 mm hex key (supplied)
- A straight edge (a combination square is shown)
- Gloves

The lower cutter straight planing knives should be adjusted so they lie level with and parallel to the cast iron cutter table.



WARNING! Before adjusting the knives on this machine always turn off the electrical circuit supplying power to the machine.

NOTICE Do not put a straight edge through the machine across the nylon inserts to adjust these knives. Use the following procedure to set these knives accurately:

NOTE: You can use a short piece of straight wood block for this, just ensure that the part is **straight** and long enough to bridge across the planer opening as shown in pictures below.

3 Setup

Leveling lower cutter straight planer knives

1. Place the straight edge across the corner of the cast iron table bed. (The base of a combination square is shown as the straight edge.) See FIG. 3-8 ..
2. Rotate the head so that the edge of the planer knife is directly under the straight edge.

If the knife is adjusted too high within the cutter head, the straight edge will be pushed out of position. If the knife it is positioned too low in the cutter head, the planer knife will not make contact, and the straight edge will not move at all. The straight edge should **move slightly** (1/16 - 1/8") when the knife edge passes beneath it.

3. Loosen (do not remove) the knife gib screws.
4. Raised or lower the knife using a 4 mm hex key (supplied).
5. Insert the 10 mm wrench in the track between the gib and the cutter.
6. Loosen (do not remove) the gib screws that hold the knife.
7. Set the knife height by adjusting the two recessed adjustment screws next to the cutter track.

The knife sides have a recess that allows access to the adjustment screw heads

8. Check that the knife is level in the cutter head by rotating the head to see if the knife blade barely comes in contact with and moves the straight edge **very slightly**. See FIG. 3-9 .
9. Adjust one side until correct, and then adjust the other side in similar fashion..

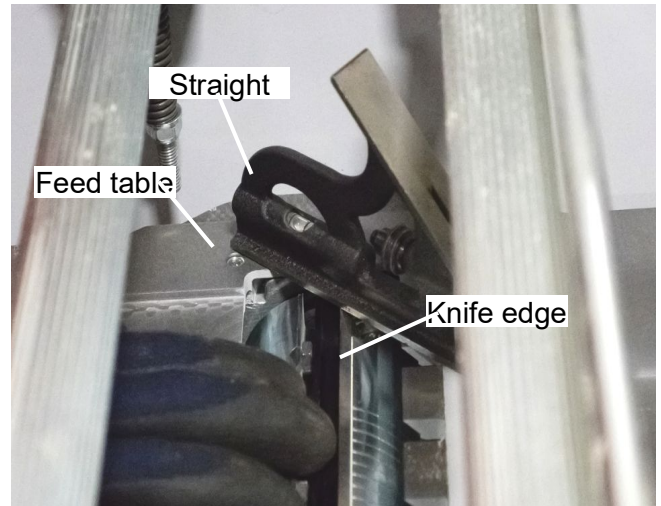

FIG. 3-8

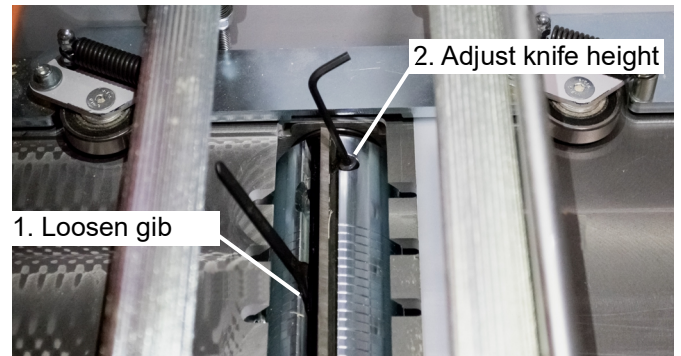
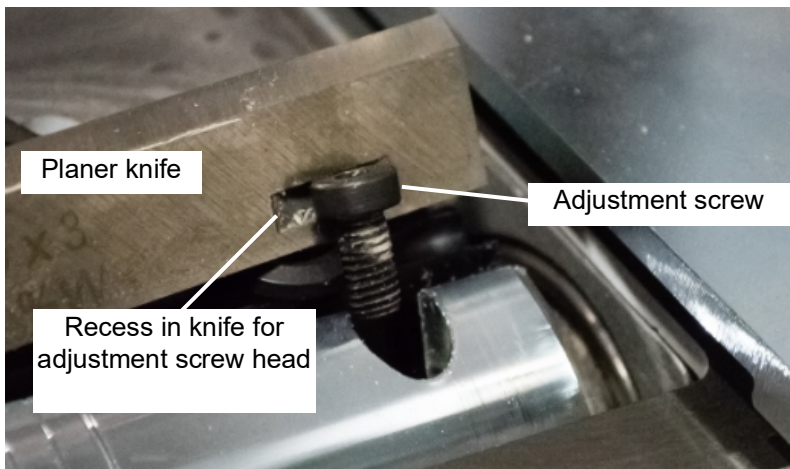

FIG. 3-9



NOTE: The adjustment screw is removed for illustration purposes. It remains in the cutter head for normal adjustments.

FIG. 3-10

NOTICE Adjusting the second side can cause the first side that you just adjusted to become a little bit off. Check the level of both sides of the knife again, and continue adjusting until the straight edge moves equally on both sides when the cutter head is rotated beneath it.

10. Securely tighten the gib screws once the knife is adjusted correctly.

NOTE: Tighten all the gib screws simultaneously, at the same rate, moving back and forth between screws. Continue repeating the procedure between screws until they are very tight.

11. Tighten the height adjusting screws until they touch bottom of the indentations of the knives. (This will be a small adjustment.)



CAUTION! If the height adjusting screws are screwed too tight, the knife will crack.

12. Repeat this procedure on all straight knives you have installed in the head.

13. Re-check that all knives are level with the cast iron table.



WARNING! Ensure that ALL of the gib screws are very tight, and that all of the knives are secure in the cutter head and before using the machine!

Rotate the cutter head completely to ensure it does not impact with anything when rotating.

Check that all parts and tools used to set the lower knives have been removed from the machine before closing the lid of the machine.

Initial setup of upper cutter



WARNING! Lock out the electrical circuit supplying power to the machine prior to adjusting the blades.

The upper horizontal cutter should be parallel to the machine table. This is set from factory, but the setting can become maladjusted by rough handling during transport or by the machine being subject to impact.

1. Loosen the screws of the bearing housings a couple of turns (two M6, and two M8 on each side).
2. Placing a **level** block on the machine table directly under the cutter head.
3. Turn the cutter head so that the block will **not** contact the knives or the knife slots.
4. Turn the table height adjustment crank (front, right corner of machine), so that the block slightly lifts the cutter head.
5. Tighten the screws of the bearing housings.

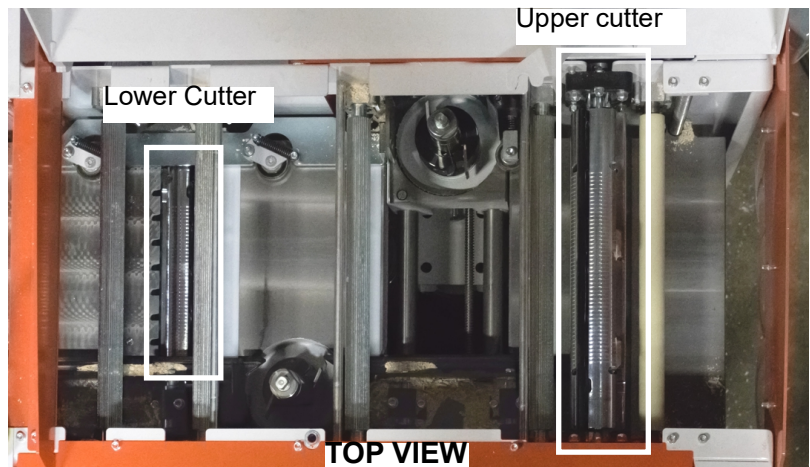

FIG. 3-11

NOTICE When the bearing housings of the upper cutter have been adjusted, or when the takeoff of the planing knives has been changed, the position of the rotating scale must be calibrated. The height scale indicator on the front side of the machine may also need adjustment.

Leveling the upper cutter straight planer knives

The upper cutter knives are adjusted in a similar way to the lower cutter knives. However, there is an aluminum knife-setting block that is supplied with the machine for the purpose of setting the upper cutter knives. This setting block can be found in the parts box that is shipped with the machine.

1. Loosen (do not remove) the knife gib screws.
2. Place the aluminum setting block (supplied) next to one of the knife adjustment screws.
3. Adjust the knife up or down with the hex key until it just barely touches the underside of the setting block.
4. Securely tighten the gib screws once the knife is adjusted correctly.

NOTE: Tighten all the gib screws simultaneously, at the same rate, moving back and forth between screws. Continue repeating the procedure between screws until they are very tight.

5. When the gib screws are tight, tighten the height adjusting screws until they touch bottom of the indentations of the knives. (This will be a small adjustment.)



CAUTION! If the height adjusting screws are screwed too tight, the knife will crack.

6. Repeat this procedure on all straight knives you have installed in the head.

Replacing cutter straight planer knives

This procedure is the same for upper and lower cutters.

1. Loosening the gib screws.
2. Loosening the knife adjustment screws until the blade is free.
3. Clean any debris or residue from the cutter head, gibs, or knives, as needed.
4. Place the new knife in at the same orientation as the old knife.

NOTE: Always place the leading edge of the knife against the gib. This is true for both straight planing knives and moulding knives in all cutter heads.

5. Level the knives as described in [Leveling lower cutter straight planer knives](#) and [Leveling the upper cutter straight planer knives](#).

Adjusting cutting depth of the lower cutter

The cutting depth of the lower cutter is set by adding or removing the adjusting plates located on the cast iron planer table in front of the lower cutter.

There are three takeoff-adjusting plates available:

- 2 mm thick with beveled holes
- 1 mm thick with beveled holes
- 1 mm thick with flat holes

The 2mm spacer is the most common setting.

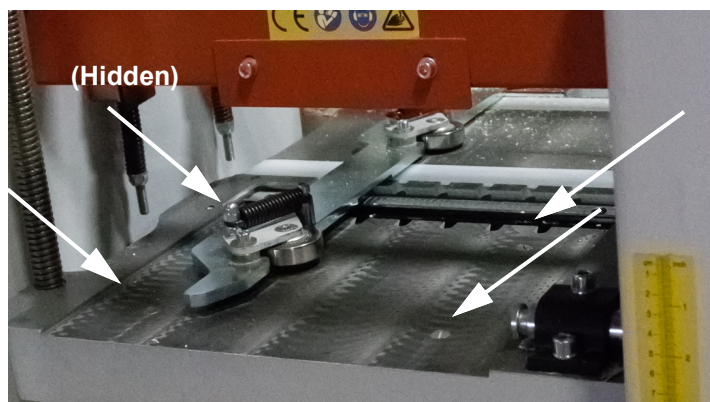

No plate currently loaded: wood takeoff would be 5/32" (4mm).

FIG. 3-13

NOTICE The 1mm plate with the flat holes should not be used alone. When used, it should be placed on the bottom or sandwiched between plates.

The adjusting plates are held in place by countersunk screws.

NOTE: The spacer plates can be fitted in two ways. For normal planing, fit the spacer so that the front plate edge is close to the lower cutter. This provides maximum support to the material while the lower cutter head is cutting it.

When profile knives are fitted to the lower cutter, the spacer is placed so that the tracks in the planer table are visible. This allows longer knives, such as bottom relief knives used for making flooring, the ability to cut without impacting the spacer plate.

Various configurations used to remove wood:

- 4 mm (5/32"), do not use any takeoff adjustment plate.
- 3 mm (1/8"), use the 1 mm takeoff adjustment plate with beveled holes.
- 2 mm (5/64"), use the 2 mm takeoff adjustment plate.
- 1 mm (1/16"), use the 1 mm takeoff adjustment plate with flat holes (on the bottom) AND the 2 mm takeoff adjustment plate.
- 0 mm, use the 1 mm takeoff adjustment plate with beveled holes, the 1 mm takeoff adjustment plate with flat holes (sandwiched), and the 2 mm takeoff adjustment plate.

Adjusting upper cutter depth

Adjusted cutting depth of the upper cutter by turning the adjustment crank handle. Each turn of the crank raises or lowers the machine table 5/32" (4 mm). The scale on the front of the machine indicates the thickness of the finished material.

By loosening the indicator screw and moving the indicator upwards or downwards, the scale can be calibrated to match the takeoff of the upper cutter.

The depth of cut is determined by the thickness of the rough board before it enters the planer, less the amount of takeoff from the lower cutter, less the amount of the thickness of the finished board.

Examples:

Imperial	
Rough lumber thickness	1-1/16 "
Takeoff of lower cutter	1/16"
Upper cutter head removes	1/8"
Resulting thickness	7/8"
Metric	
Rough lumber thickness	26 mm
Takeoff of lower cutter	2 mm
Upper cutter head removes	3 mm
Resulting thickness	21 mm

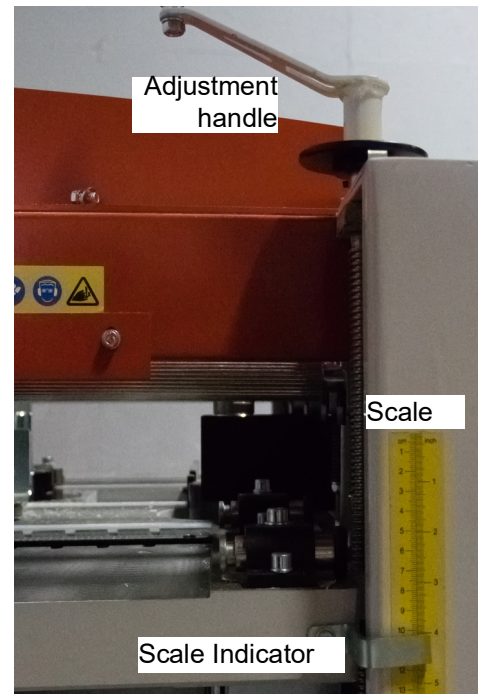

FIG. 3-14

Moulding knives in upper and lower cutters

Moulding knives can be mounted both in the lower and the upper cutter.

NOTICE The moulding knives must always be mounted in pairs and in the same lateral position in the opposite slots of the cutter head. A small degree of lateral deviation between the moulding knives can be accepted, as long as the cutter head stays balanced.

3 Setup

Side cutter setup

The lower and the upper cutter have four knife slots each. The machine comes with two mounted planing knives in each horizontal cutter. In the two empty slots you can mount moulding knives of different sizes and profiles.

WARNING! Ensure the cutter head is balanced.

NOTICE If back relief knives are mounted in the lower cutter, position them laterally so they pass through the tracks in the machine table.

NOTICE On the chassis above the machine table on the in-feed side, there is a **limiting plate** which limits the maximum takeoff of the upper cutter when it is turned up-side-down. **This plate must be used when moulding knives are mounted in the upper cutter.** If an over-thick workpiece is fed through the machine, the feed rollers may come in contact with the moulding knives if this limit plate is not used.

1. Assemble the knife clamping gib and the moulder knife. See FIG. 3-15 .
2. Insert the gib and the moulding knife in the wide end of the slot in the cutter head.
3. Push the knife and the gib along the slot, and then fasten them by turning the screw on the back of the gib counterclockwise so that it presses against the side of the slot.

NOTICE The gib screw must be fixed in the narrow part of the slot. It must not be fixed in the wide end of the slot.

4. Measure the lateral position of the knife, and fit an identical knife in exactly the same position on the opposite side of the cutter head.

3.5 Side cutter setup

WARNING! Before adjusting the knives on this machine always turn off the electrical circuit supplying power to the machine.

Wear gloves when working with knives in the machine.

CAUTION! Check for tools used in the operation and remove from the machine before closing the lid.

NOTICE Check for free rotation of cutter heads before closing the lid.

TOOLS NEEDED:

- 12 mm open-end wrench.
- 30 mm open-end wrench (supplied).
- 4 mm hex key (supplied).
- Gloves.

SIDE CUTTER DESIGN (SEE FIG. 3-16 .)

The side cutters have the following specifications:

- Spindle Axle: Diameter 30 mm
- Cutting Height: Maximum 4" (100 mm)
- Rotation Speed: 7000 rpm
- Cutting Depth: Maximum 1 3/32" (28 mm)

Specifications of the side cutter heads :

- Diameter: Body 3 1/2" (90 mm)
- Height: Body 1 9/16" (40 mm)
- Planer Knives: HSS (High Speed Steel)
- Knives: Width 1 33/32" (50 mm)

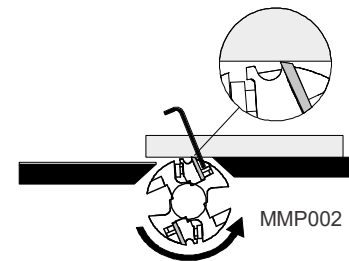
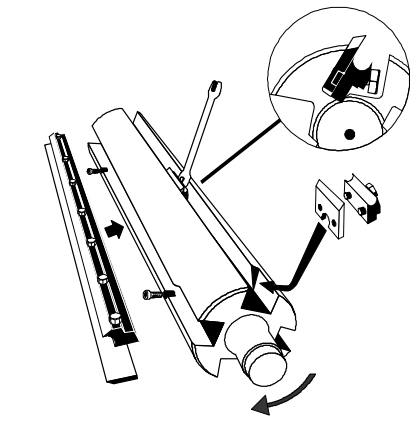

FIG. 3-15

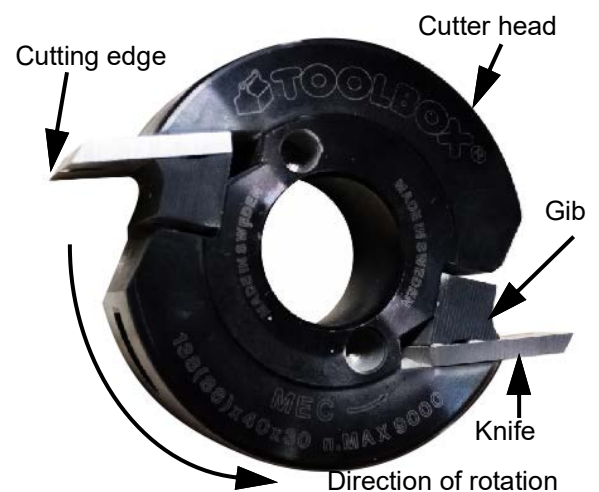

FIG. 3-16

REMOVING RIGHT OR LEFT SIDE CUTTER



WARNING! Wear gloves when working with knives in the machine.

Use the 30 mm and 12 mm open-end wrench in combination to loosen the nut on the top of the shaft. See FIGs 3-17 and 3-18.

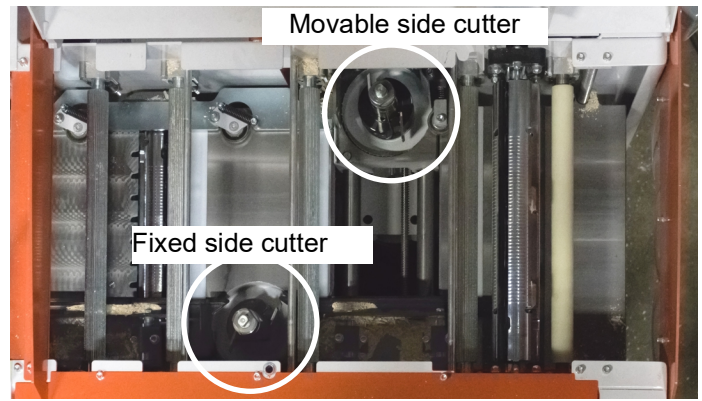

TOP VIEW

FIG. 3-17

Loosen the nuts on the side cutters by screwing them in the same direction as their respective cutter rotate.

REPLACING KNIVES

1. Loosen the lock screw with a 4 mm hex key (supplied).
2. Remove the gib.
3. Remove the knife from the dowel pins.
4. Insert a new knife and gib.
5. Screw the lock screws tight.

NOTICE Ensure the knives are mounted in the proper orientations for the rotation of the head.



NOTE: The lock nut and the spindle of the **movable side cutter** have left-hand threads.

FIG. 3-18

Ensure that the chip deflector in front of the movable cutter does not get bent by the unplanned edge of the work piece coming in contact with the cutter. Be cautious processing work pieces of various widths.

Ensure that the cutter head can rotate freely, and that there is approximately 5 mm (0.2") between the outermost cutting diameter of the cutter and the chip deflector that works as a chip barrier behind the movable cutter. See FIG. 3-19 .

SETTING SIDE CUTTER KNIFE HEIGHT

Included with your planer is a package of shims/spacers of various thicknesses for the side cutter heads. These shims are packed in the parts box that is packed with your planer.

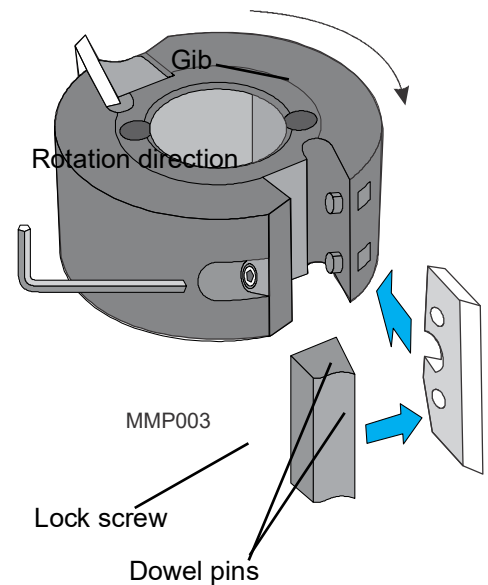

FIG. 3-19

3 Setup

Setting the movable side cutter head

Side cutter shims are used to raise the cutter head up and down on the cutter shaft. Using shims allows the precise setting of the cutter head, and when locked in place, your setting will not change. Also, shims provide you the ability to easily change your settings, as well as the ability to return to specific settings, as long as you record the shims that are used in that particular setup.



40 mm Spacer
20 mm Spacer
10 mm Spacer
5 mm Spacer
Set of Spacers (0.1 - 2.0mm)

FIG. 3-20

RAISING OR LOWERING THE CUTTER HEAD

Remove the cutter head and determine the amount of shims to place under the cutter head to achieve the correct height of the head.

You may have to try several combinations of shims in order to achieve the correct height setting for the side cutter knives. See FIG. 3-20 .

Replace the cutter in the same orientation as it came out.

NOTICE Replaced the cutter heads back in the machine with the knives facing the correct direction. The leading edge of the knife should always turn into the wood. Ensure this knife is cutting into the wood when the head is rotating.

LOCK THE CUTTER HEAD IN POSITION

Place the large spacer rings above the cutter head. Only the treaded portion of the shaft should be visible.



CAUTION! If the spacer rings are not stacked properly, the cutter head may spin on the shaft, causing the shaft to become scarred and damaged.

The top nut should then be replaced on the top of the shaft using two open-end wrenches – one to hold the shaft, and one to tighten the nut.

Setting the movable side cutter head

The movable side cutter head has a locking bolt **under the table**, on the output side and a locking screw accessed on the top of the table.

1. Loosen the movable side cutter locking bolt by the handle. See **OUTFEED VIEW**.

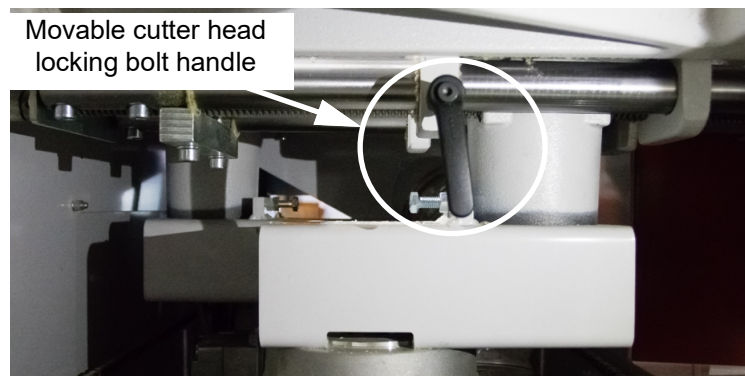

OUTFEED VIEW

FIG. 3-21

2. Use the crank on the front of the unit to move the side cutter in or out to the desired location to cut the left side of the board. See FIG. 3-22 .

This initial setting will only be an approximation; for now, we are mainly setting the second right side fence. Once this second right side fence is set, you will be able to accurately measure the desired width.

SETTING THE LEFT SIDE PRESSURE ROLLERS

There are two pressure rollers on the infeed arm and one on the outfeed side of the movable cutter head. The pressure rollers hold the board against the side cutter fence.

The infeed pressure rollers are mounted on a bracket attached to the movable side cutter. It moves with the side cutter.



FIG. 3-22

The pressure roller bracket fits into a groove just in front of the side cutter and can be moved in or out as needed to allow for varying width boards. Where this bracket is placed also determines the widest board the machine will accept. The pressure rollers should be set to approximately 1/8" less than the board width.

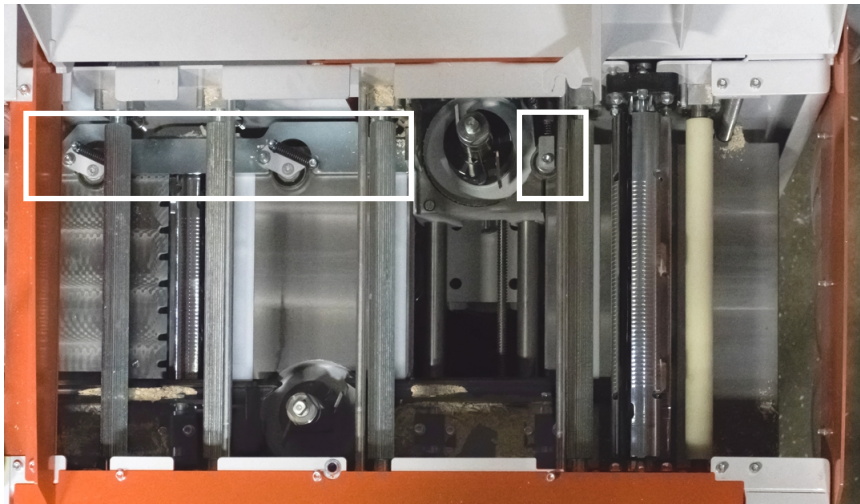

FIG. 3-23

1. Set the pressure rollers by loosening the screw (6 mm hex key) that **secures the roller bracket on the movable cutter carriage**.
2. Adjust the bracket so that the pressure rollers are pressed in approximately 0.2" (5 mm) when the work piece is fed into the machine. The pressure rollers do not need adjusting.

Behind the movable cutter there is an additional pressure roller, which presses the work piece against the back fence.

3. Set the additional pressure roller so that it extends approximately 1/32 - 1/8" (1-3 mm) past the cutting diameter at the level of the pressure roller. See FIG. 3-24 .

3.6 Feed rollers

The MP260 has five feed rollers, which feed the work pieces through the machine. Four of these rollers are of ribbed metal and the last one has a rubber coating so that the surface of the work piece will not be marked when it exits the machine.

The feed rollers are run by a separate motor with a planetary gear. The rubber roller goes into the planetary gear. On the rubber roller there is a sprocket, which drives the other four feed rollers via chain transmission.

Adjusting the feed roller pressure

On each end of the feeding rollers, there is a spring mounted bearing housing. Under the bearing housing there is a spring on a threaded bar. The pressure the feed rollers apply to the work piece can be adjusted by turning the nut on the bottom of each threaded bar. Ensure the pressure is the same at both ends of the feed rollers.

Lubricate the bearing housings of the feed rollers with oil after each work session.

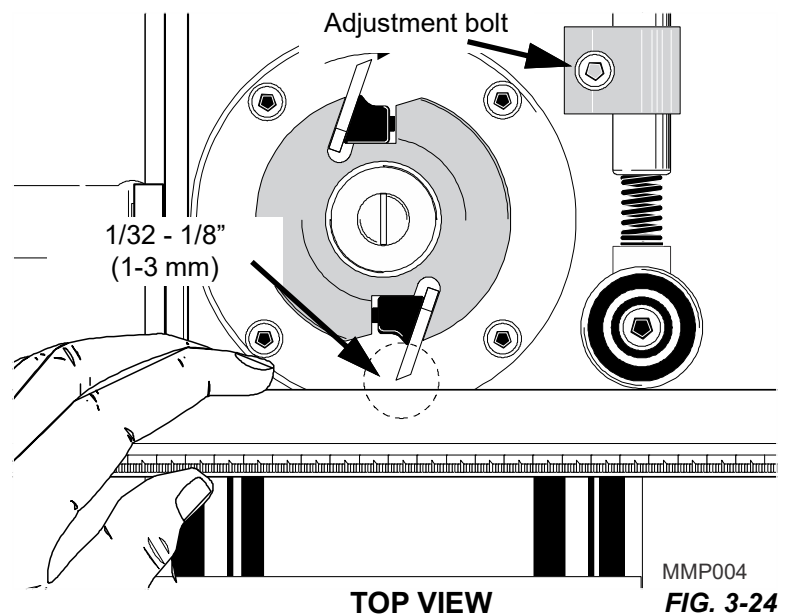

The rubber roller should also be adjusted so that it applies just the right pressure to the work piece. Remember that this feed roller should be set by the thickness the work piece has when leaving the cutters.

NOTICE Wood debris can accumulate under the feed roller spring mounted bearings. This impairs the feeding and increases the risk of the work piece being hurled out of the machine. Check these areas and, if necessary, remove the wood debris that has accumulated there.

Adjusting the feeding speed

The stepless feed speed can be adjusted by turning the knob on the planetary gear. If the knob is turned clockwise the feed speed is increased; if it is turned anticlockwise the feed speed is lowered.



CAUTION! Do not adjust the feeding speed if the motor of the feed rollers is not running. Equipment damage may occur.

The optimum feeding speed varies depending on what sort of wood you are machining, the moisture content of the wood, and what type of moulding knives you have mounted in the machine. The feeding speed can be adjusted from 2 m/min. to 12 m/min.

3.7 Leveling the machine table

NOTICE Leveling the machine table is a complicated operation. Ensure that this operation is necessary before beginning any adjustments.

The machine table is already leveled from factory, but the table can have changed its position by rough handling during transport or by the machine being subject to impact.

INDICATIONS THAT THE MACHINE TABLE IS NOT LEVEL

- The upper cutter cannot be adjusted so that it is parallel to the machine table
- The crank for raising and lowering the table is difficult or impossible to turn.
- The chain that connects the trapezoidal threaded bars that holds the machine table has come off or has moved incorrectly on a sprocket.

LEVELING THE MACHINE

1. Set the both bearing housings of the upper cutter in their lowest position. (See [Initial setup of upper cutter.](#))
2. Place an absolutely level block on the machine table directly head (not against the knives or the knife slots).
3. Turn the machine table crank until the block comes very close to the cutter.

If it is impossible to raise the table, you need to take the measurement between the table and the cutter head instead of using the block. This operation is slightly more difficult.

4. Loosen the chain for the machine table by opening the chain lock (take the opportunity to clean and lubricate the chain).
5. Turn each of the threaded bars until the cutter head touches the block along its entire length (alternatively, measure between the table and the cutter head).

Each threaded bar has to be turned a little at a time to avoid the table getting locked due to angular misalignment. Do not use force.

6. Check the table's position lengthwise in the machine by measuring its height against the upper edge of machine frame, and level the table in this direction as well.
7. Ensure that all the threaded bars are easy to turn.

If a threaded bar is difficult to turn, it is due to angular misalignment of the table. Adjust this by slightly turning the difficult bar, even if this results in the table being not completely level. This deviation is taken care of by fine-tuning the position of the upper cutter. (See [Initial setup of upper cutter.](#))

8. Ensure that the table cannot be wobbled diagonally.
9. Place the chain on the sprockets and tension the chain using the chain tensioner on the out-feed side of the machine.

NOTICE When the bearing housings of the upper cutter have been adjusted, or when the take-off of the planing knives has been altered, the rotating scale has to be calibrated. Possibly, the pointer on the height scale on the front side of the machine also has to be adjusted.

3.8 Running the first test board



WARNING! Check for tools used in the operation and remove from the machine before closing the lid.

NOTICE Check for free rotation of cutter heads before closing the lid.

Use a board approximately 3 feet (1m) in length and uniform in dimension for the first run of the machine. In order to set the second right side cutter fence this board should be stopped before it runs completely through the machine. Specifically, the board should be stopped just in front of the pressure roller located just after the left side cutter.

1. Turn the machine on using the start button located on the control panel. See FIG. 3-25 .
2. Start the cutter heads one at a time.
3. Start the feed motor last.

A light above the start buttons should illuminate as the motors are started.



CAUTION! Do not adjust the feeding speed if the motor of the feed rollers is not running. Equipment damage may occur.

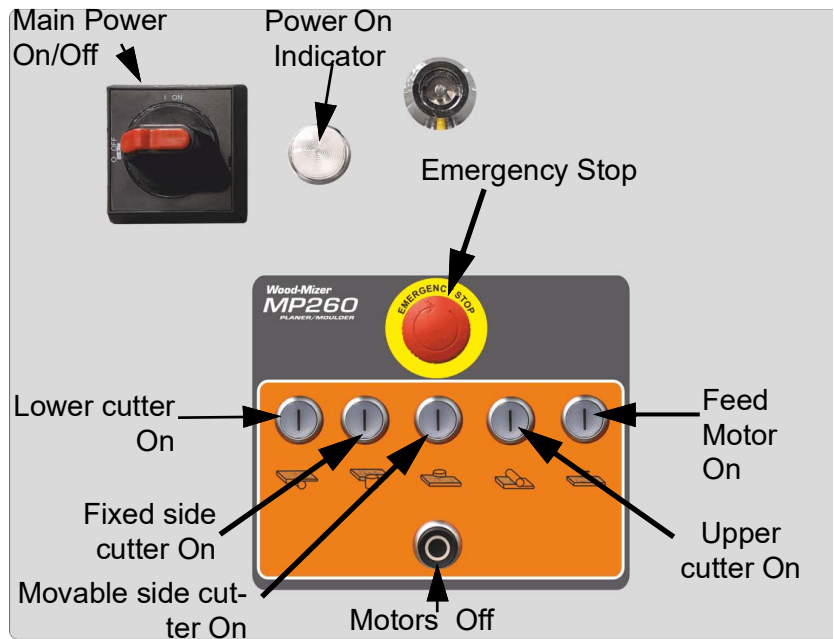

FIG. 3-25

4. Slow the speed of the feed rollers down using the knob on the planetary gear. Turn the knob until you see the rollers slow down to their lowest speed.
5. Place the board on the infeed side of the table against the fence.
6. Slide the board into the machine, with the right side firmly against the fence, until you feel the feed rollers begin to pull the board through the machine.
7. Watch the board feed through the planer through the observation window that is integrated into the lid.
8. Stop the machine with the stop button when the board gets just past the left side cutter, just before it comes in contact with the pressure roller next to the left side cutter.

Check the length of the fence. If needed, loosen the bolts holding the front of the fence to the mounting brackets, sliding the fence to the correct position. Be sure and check rotation of the right cutter head before setting.

Side cutter fence setup

The right side cutter has two fences: the first and second side cutter fence. They are both attached in similar fashion to the cast iron table.

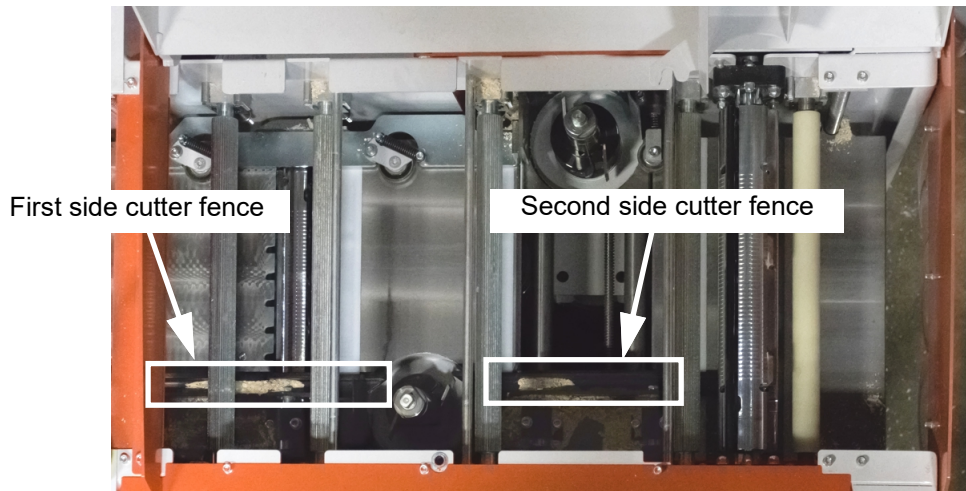

FIG. 3-26

SETTING THE SECOND SIDE CUTTER FENCE

The second side cutter fence is located on the far side of the stationary cutter. See FIG. 3-26 . It is set back away from the path of the wood initially.

Pass a test board through the machine and then stop it in place.

Bring the second side cutter fence up to the wood and bolt it firmly against the wood. See FIG. 3-27 .

When your test boards are complete, and you are satisfied with your setup, you can begin running material through the machine.

FEEDING THE MACHINE

Ensure you have adequate room for the material that you will be putting in to and taking out of your planer. Your work area should be well lit, and clear of loose items on the floor, so there is little risk of tripping when handling long material. The paths to the infeed and outfeed ends of the machine should be clear.

Material should be placed close to the infeed end of the machine for quick feeding into the machine and a stacking area should be prepared at the outfeed end.

Once the machine is started and boards are fed into the machine, it is recommended to keep the material going through the machine one board after another, with the two boards touching.

Place the straightest edge of the material against the right side fence. Ensure it is fed into the machine with the edge against the first right side fence. Material that is fed into the machine at an angle will not straighten up in the machine and may cause problems with fences.

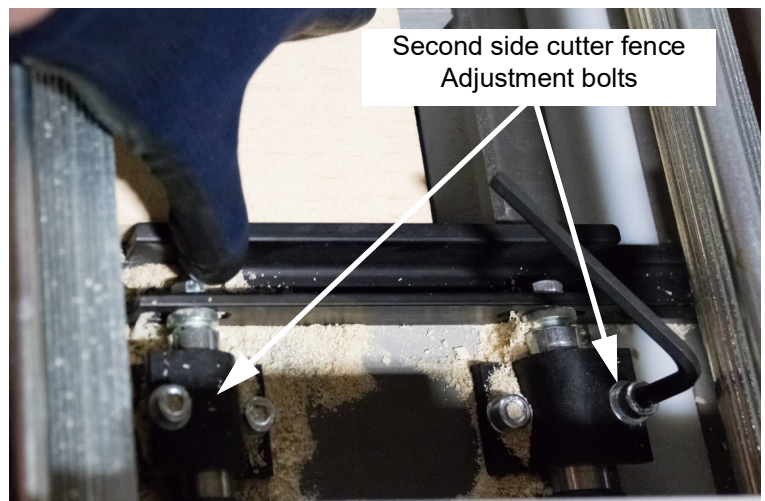

FIG. 3-27

SECTION 4 OPERATION

4.1 Operation



DANGER! Keep hands away from the knives.

Ensure all knives are secure before starting motor.

Do not operate the planer moulder without all covers and guards in place.



WARNING! Do not operate the machine standing directly in front of the input or output tables; kickbacks may occur.

Minimum length of the work piece is 24" (600 mm). Do not feed shorter pieces.

Read and understand all information and warnings contained in the **Safety** section of this Operators Manual **before starting the planer.**



STARTING THE PLANER



WARNING! Clear the machine of any loose tools or other items before starting any of the motors.

NOTE: Motors will not start if the planer's observation/protective lid is not securely closed, or if the Emergency Stop Button is depressed. Ensure the Emergency Stop Buttons in the correct position by depressing it and then pulling and/or turning it until you here a click.

Ensure each cutter head moves freely and will not impact any fences before starting.

The MP260 control panel is located at the infeed end of the machine.

Main power to the machine is supplied through the switch at the top left corner of the control panel.

1. Turn Main Power switch to On. See FIG. 4-1
2. The Power Indicator lights.
3. Press each motor button independently.

STOPPING YOUR PLANER UNDER NORMAL OPERATING CONDITIONS

1. Press the Motors Off Button. See FIG. 4-1

This stops all motors at once. All of the motors can be restarted again after this stop button is pressed.

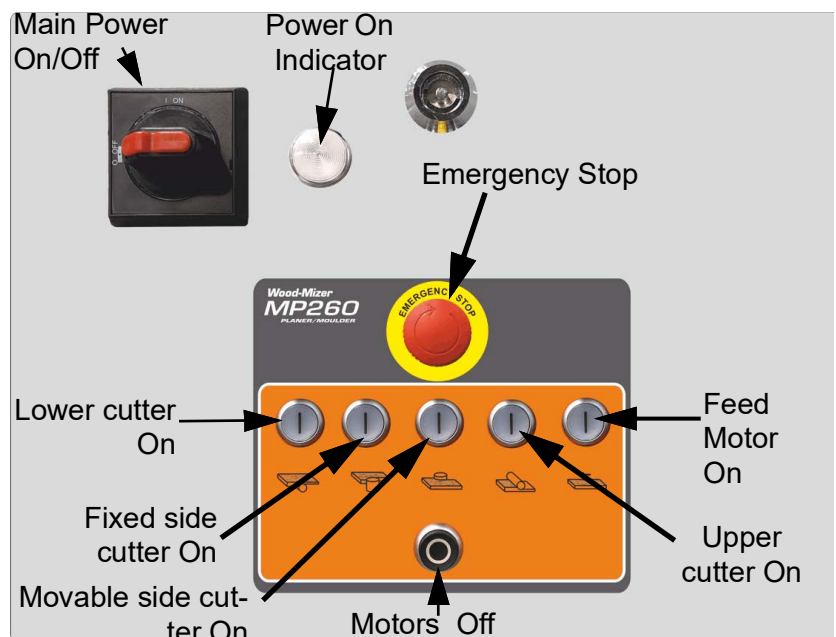

FIG. 4-1

STOPPING YOUR PLANER IN AN EMERGENCY

1. Press the Emergency Stop button to stop all motors.

Once this button is pressed, the machine cannot be restarted until this button is turned 90° and pulled out to reset.



CAUTION! After every emergency stop wait at least 10 seconds before restarting the machine. If you do not wait, the fuse on the brake card may blow or, if that fuse fails, you will damage the brake card.

4.2 Planing tips

General recommendations

- If the knives in the upper cutter protrude too much, the last feed roller will not take hold of the workpiece. Recommended protrusion is 1 mm.
- A planer/moulder is not a jointer; it only dimensions and moulds the workpiece.
- Keep the feed rollers clean from wood debris. The out-feed roller is especially important, since wood debris on this roller can make marks in the planed surface of the workpiece.
- For slightly convex boards, feed the board with the convex side upwards. Set the first feed roller so that its pressure is somewhat lower than the pressure of the feed roller behind the first planing cutter.
- Be careful when adjusting the side fences. The back fence is to be level with the outermost cutting diameter of the cutter. The two fences should be parallel with each other and set so that the board is fed slightly diagonally (totally about 5 mm towards the left) through the machine. By this the feed rollers will press the board against the fences.
- If you are going to produce a large amount of a moulding there is an additional locking screw to secure cutter 3. The locking screw is recessed in a hole on the top of the carriage.
- Use in- and out-feed tables. Ensure that they are mounted exactly at the same height as the machine table. Set the out-feed table so that it slants upwards a couple of degrees. By this the board will be pressed down against the table when reaching the last cutter, which reduces the risk of out-feed marks.
- Reduce the air flow in the chip hose at cutter 2 when this cutter is to take off little wood from the work piece. This will increase the air flow at the other cutters.
- If you want to keep a roughly sawn surface on one side of the board, e.g. when making outdoor siding that is to be painted, you let that side face the machine table and do not start the lower cutter.
- If you want to produce thinner three-sided mouldings than the machine is designed to make, you can place a flat board on the machine table which will make the workpiece come in a higher position in the machine.
- The pressure springs of the feed rollers are to be set so that the feed rollers balance on the workpiece. If the feed rollers lie diagonally over the workpiece they can pull askew and, in addition, the grooves in the rollers will make deep marks in the workpiece. Balancing the feed rollers is extra important when thin workpieces are machined. When changing from the 2-12 m/min. feeder to the 4-24 m/min. feeder, the pressure of the last feed roller has to be adjusted due to the weight of the planetary gear.
- The chip extractor moves a large amount of air. If you blow the wood debris out of a heated room, the room will quickly become cold.

Sizing stock

This planer/moulder works best as a finishing planer/moulder. You can take rough lumber right out of the stack and plane it smooth. However, to achieve the best results with this machine, it is best to have your stock as close to the size of the finished product as possible. If you are planing with lumber that has a wide variance on thickness, it is best to run this lumber through either this planer or another planer to size it to a uniform thickness before finish planing and moulding it with this planer.

Some types of wood are prone to splintering. If you are taking too deep of a side cut, the wood can splinter and pull into the left side cutter. You can prevent this by reducing the depth of cut that is taken off of that side of the stock.

For certain applications such as flooring, the lumber might need to have one side ripped to provide a straight edge. Your planer will not make a crooked board straight. If straight material coming out of the planer is a requirement, then straight material will have to be fed into the machine. Subjecting lumber to a straight-line rip will take the wane out of a board. Place the ripped edge against the right side fence when feeding this ripped material through the machine.

Planing narrow stock

The MP260 can process very narrow stock. However, a motion-limiting block is positioned in the machine between the two tubes that the left side vertical cutter head moves on. This limiting block is held in place by two bolts that are accessible underneath the block. Take out the two bolts that hold the upper and lower halves of this block together, and remove the block.

Replace the motion-limiting block back into the machine when you are not planing narrow stock, as this block provides additional support to boards as they move through the machine, and across the width of the cast iron table.

Planing stock thicker than 2 Inches

The planer can mould and plane stock thicker than two inches with the side heads. To accomplish this two cutter heads must be stacked. When placing these cutter heads in the machine, be sure to place the cutting knives on the second head halfway between the two knives on the first cutter head on that spindle.

Spacers can be used to add height to the upper cutter head; however, it is best if there is some overlap of the knives, especially with straight knives.

Cutter heads with a 4" height designed for this model can be ordered through Wood-Mizer.

Saving a moulding pattern

If you have produced a moulding that you know you will produce in the future, it can be wise to take some measures before removing the mounted knives. This will ensure that you can quickly set the machine for making the same moulding again.

1. Use a board that is approximately the same length as the moulder as your last run piece.
2. Stop the feed-in of this board as it is halfway through the cut.
3. Adjust the table and the moveable side cutter so that the board may be removed.
4. Write down on the board the setting of the height scale of the table and the rotating scale on the height adjusting crank, i.e. exactly note to what height the machine table is set. Also measure the machined moulding. Measure and note the spacers and the position of profile blades on the board.

Tongue and groove

When setting up this machine for tongue and groove material, start with several short pieces of stock similar in size (width and thickness) to your finished product.

For tongue and groove that you have kept a sample from a previous run of this material, place the tongue and groove board from this previous run in the machine and match the knife height to match this original board.

1. Set the side cutters to the initial height by measuring with straight edges from the cast iron table to the bottom of the groove.
2. Run a short test board through the planer.
3. Cut the test board in half and test the match.
4. To correct a mismatch, lay the two boards together on a flat surface. Slide a thickness spacer ring(s) under the lower board until it is level. Use that spacer or combination of spacers to level the cutting head.

SECTION 5 MAINTENANCE



DANGER! Remove power before clearing debris or **any other maintenance activity**. Failure to follow this will result in serious injury or death.

Follow the OSHA lockout procedures reprinted in the safety section. (See [Electrical lock-out procedures](#) in [SECTION 2 General Safety](#).)

5.1 Overview

Your planer is a precision machine, and will provide you with professional results if kept in good condition. Proper setup, alignment, cleaning, and lubrication are essential to the successful operation of the machine.

All knives must be kept sharp and uniform to ensure the quality of cut and efficiency of operation. Operating your planer with dull knives will put undue stress on the machine, shortening its life.

5.2 Workspace Tips



DANGER! Maintain a clean and clear path for all necessary movement around the planer moulder, tools, and material stacking areas.

Having a clean and organized work area helps prevent most of the types of accidents that commonly occur in a workshop environment.

- Have designated areas for tools, knives, shims, cleaning rags, scraps of material, and anything else that may accidentally be placed/left in the machine.
- A tool board with designated spaces is an excellent way to always know where your planer tools and accessories are located.
- Locate your tool board close by your planer so that before you start your machine, you can look at the tool board and see if any tools are missing or left in your machine.

5.3 During use

1. Clean the machine from wood debris.
2. Ensure that wood debris does not accumulated under the machine.

Debris/dust can interfere with the cooling of the motors and lead to a motor breakdown or, at worst, fire. The belt under cutter 4 can become slack if wood debris accumulates under its motor.

3. Ensure that all chip outlets are connected to the chip extractor.
4. Ensure that all feed rollers are moving freely.

5.4 After each use

1. Clean the machine from wood debris. Also check the chip outlets and the hoses. Remove wood debris that has accumulated under the machine.
2. The machine table should regularly be cleaned and treated with a lubricant, for example low-viscosity oil, silicon lubricants, or wax (3-1 oil, ChuteLube, silicon sprays, etc.).
3. Clean the cutters and the feed rollers from resin and accumulated wood debris with mineral spirits

NOTICE Wood debris can accumulate under the spring mounted bearings of the feed rollers. This impairs the feeding and increases the risk of kickbacks.

4. Ensure that wood debris has not accumulated behind the right side bearing housing of the upper cutter. If so, clean away the debris.
5. Clean out any wood debris accumulated in the springs under the bearing housings of the feed rollers.

NOTE: Sometimes the spring must be removed from the threaded bar to be cleaned.
Note the setting of the spring before removing it.

6. Clean and lubricate the pressure rollers so that they can move easily.
7. Check all belt tensions.
8. Ensure that all screws and bolts are tight.
9. Ensure that all cables and connections are in good condition.
10. Check the lamps by pressing down the emergency stop button and then the start button of the feeder.

5.5 Lubrication points

NOTE: Use a chain/gear oil with ISO Viscosity Grade 68.

1. Lubricate the bearing holders and springs of the feed rollers.
Total of 10 - four steel rollers and one rubber

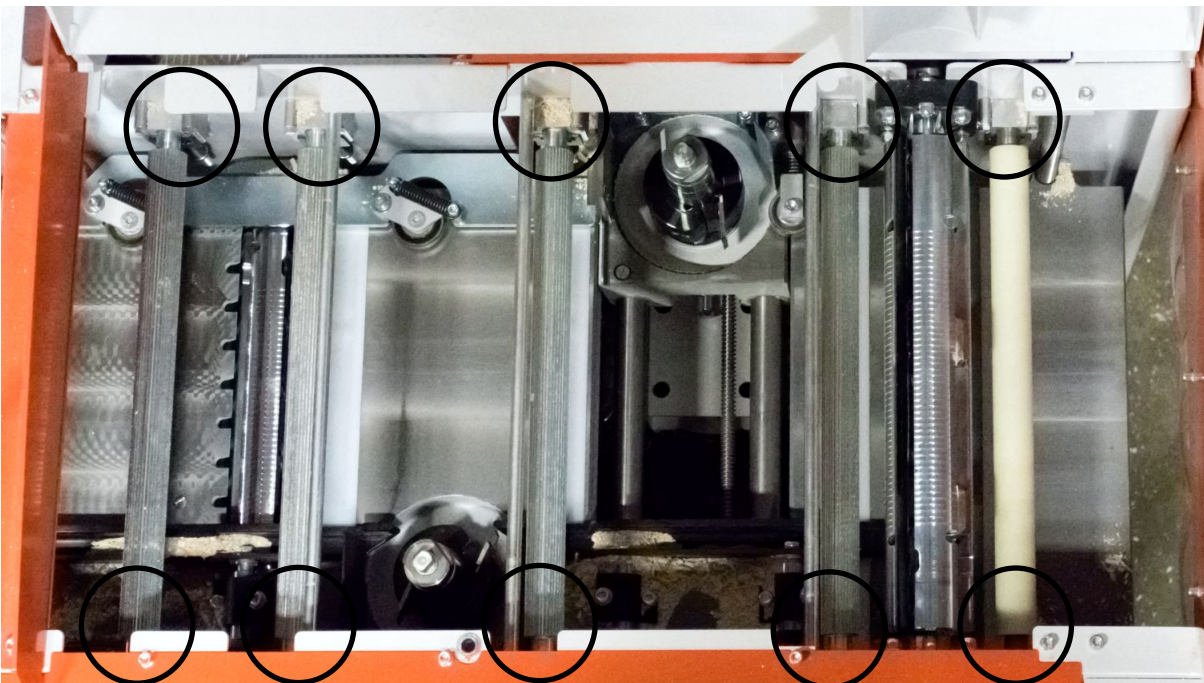

FIG. 5-1

2. Lubricate the trapezoidal threaded bar located at all four corners



FIG. 5-2

3. Lubricate the chain and sprockets for height adjusting the table. Check the tension of the chain..



View from bottom, looking up; outfeed side; cover panel removed

FIG. 5-3

4. Lubricate position bars and the threaded rod on the carriage of the movable cutter..

If the movable cutter is set in the same position for a long time (e.g. when producing long series of the same moulding) it can rust. Set the cutter so that it is in its outermost and innermost position once or twice a month, and lubricate the threaded bar of the crank and the position bars of the carriage.

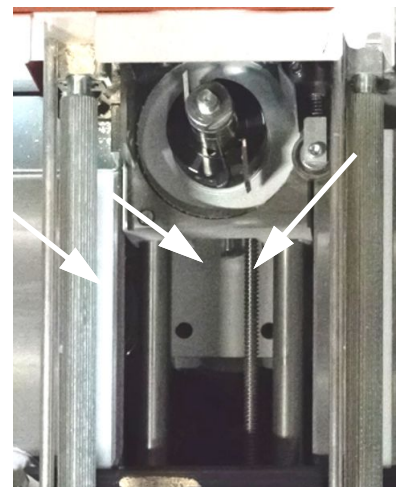

FIG. 5-4

5. Remove the cover and lubricated the chain transmission of the feed rollers.

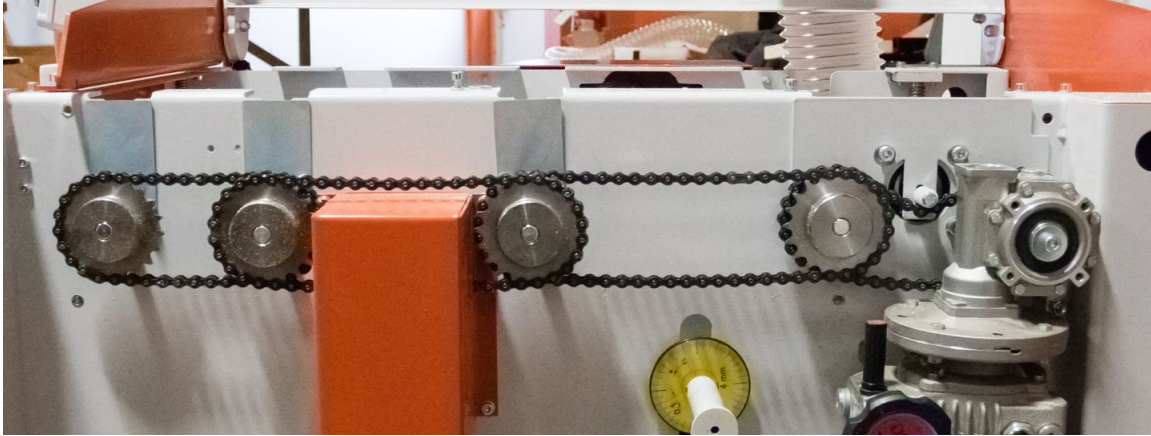

FIG. 5-5

6. Lubricate spacers, pressure rollers, and side rollers.

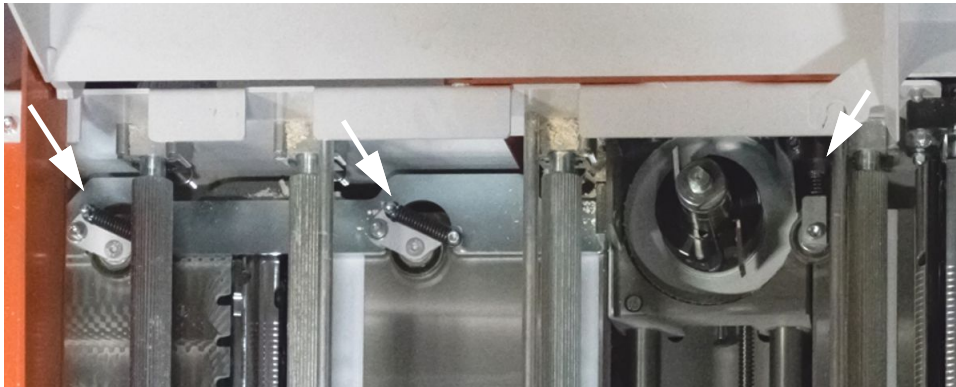

FIG. 5-6

5.6 Cleaning the metal feed rollers

Pitch may build up on the metal feed rollers from planing high resin woods.

1. Clean pitch buildup from the feed rollers with a soft wire brush (i.e. a brush with brass bristles) and some cleaning solvent to assist in loosening the pitch.



CAUTION! Do not spray/pour cleaning fluid directly on to the feed rollers. This may enter areas of the machine where it can cause damage and/or remove necessary lubricant.

2. Place the cleaning fluid on a high-nap cloth and wipe down the rollers with it.
3. Use a wire brush to assist in removing the pitch from the grooves on the roller.
4. When the rollers are completely clean, wipe them down again with a high nap cloth.
5. Finish by spraying a cloth with lubricant (high-quality silicone spray or WD-40) and wiping down the rollers to prevent the future buildup of pitch.



DANGER! Dispose of cloths/rags used with flammable cleaning or lubricating fluid **properly** to avoid spontaneous combustion.

NOTICE If you are selling your shavings for livestock purposes, this may limit the type of cleaning fluid you can use for this purpose.

5.7 Table lift assist chain adjustments

The height of the cast iron table on your machine is adjusted by operating the removable crank handle located on the infeed end of the machine. The crank handle is connected to a chain, which in turn is connected to the four threaded steel rods, which are threaded through the cast iron table. Eventually, through use, the chain will stretch slightly.

If this chain becomes stretched/slack, a sprocket (located at the bottom of the threaded rods) may skip a link during operation. When this occurs, the threaded rods will not be synchronized with each other and the cast iron table will not be level. Another way to say it is that the “timing” of the four threaded rods is now out of synchronization, and the four corners of the cast iron table will not raise and lower at the same rate. See FIGs. 5-7 and 5-8.

1. Remove the cover panel by using a 5 mm hex key.
2. Loosen the sprocket nut by using a 17 mm wrench.
3. Move the adjustment sprocket to take any slack out of the chain, and then retighten the sprocket nut.



Outfeed view, chain adjustment sprocket lock nut - use 17mm wrench
FIG. 5-7



View from bottom, looking up; outfeed side; cover panel removed

FIG. 5-8

5.8 Replacing feed chain gear sprocket set screw

The feed roller sprockets in the MP260 are equipped with set screws that are designed to shear off their heads if your planer gets in a bind. For example, if the size of the material being fed into the machine is more than the machine can handle, the feed roller sprocket set screw will break off to protect the feed motor and drive train of the machine.

1. Use a 4 mm hex key to remove set screws.
 If sheared, remove these set screws and re-install new set screws in the feed roller sprocket.
2. Activate the feed mechanism until the set screw is opening downward.
3. Tap the front of the sprocket/gear with a piece of wood, causing the head of the sheared screw to fall free.
4. Ensure the set screw hole is still aligned with the channel in the shaft.

NOTE: If the sprocket rotated on the shaft, it must be removed and re-aligned. Use a common automotive gear puller for this purpose. Ensure that you do not place the gear puller arms behind any of the sprocket/gear teeth, possibly bending or damaging them.

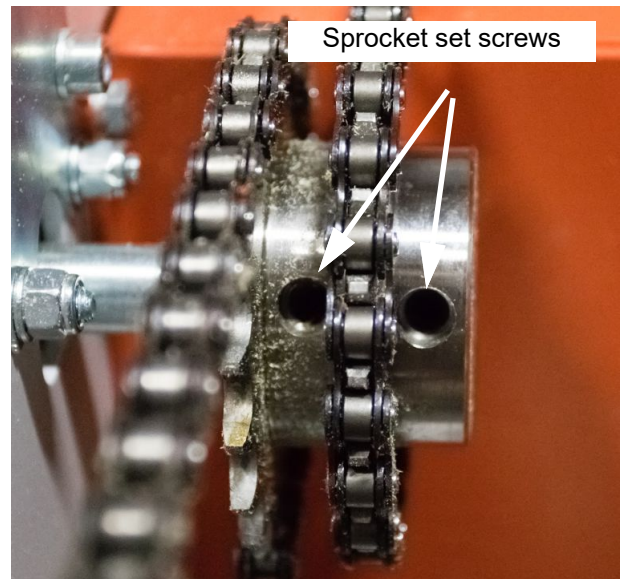

FIG. 5-9

During the assembly process, a rust preventing varnish was applied to the feed sprocket and the feed roller shaft. Before replacing the feed sprocket, it is recommended:

- a. This varnish be removed to assist reassembly.
 - b. Use emery cloth to lightly polish and remove the varnish that is on/around the shaft.
 - c. Lightly polish and remove the varnish that is on the inside of the hole in the feed sprocket/gear.
 - d. Place the feed sprocket on the shaft, aligning up the set screw hole on the feed sprocket to the channel on the shaft.
5. Replace with a new set screw.

5.9 Removing and replacing feed chains

Each chain has a master link, which must be disassembled in order to remove the chain. The master links come from the factory facing outward, and they are easily recognizable because they look different from the rest of the links. See FIG. 5-10 .

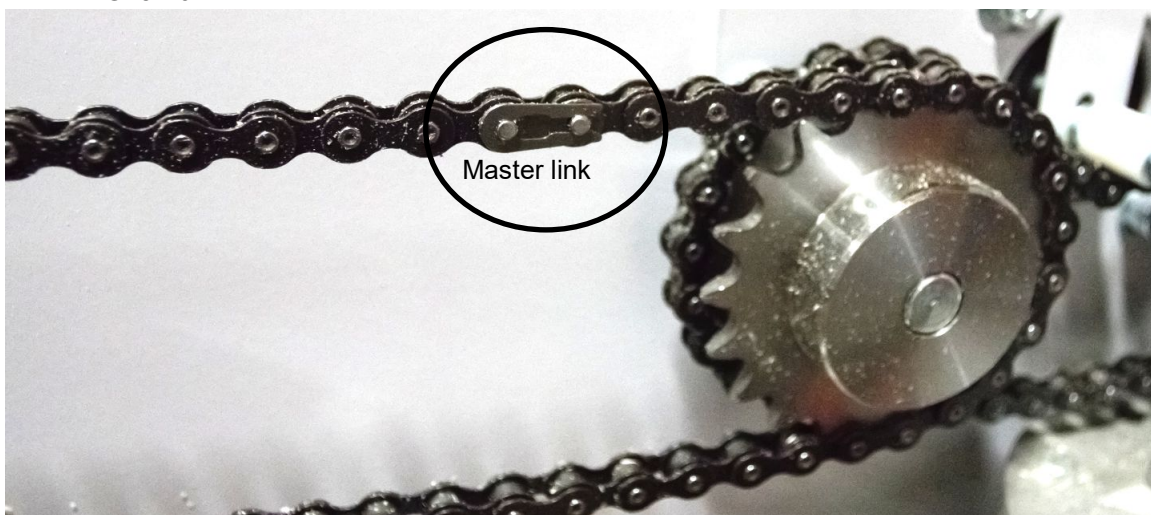

FIG. 5-10

Remove the master link by placing a flat tip screwdriver behind the ends of the C-clip, apply pressure, and carefully push the C-clip off of its mounting points.



NOTICE The C-clip is made from spring steel and can easily fly off, getting lost during the removal operation. Perform this operation in a clean, well-lit area.

5.10 Replacing Belts

The power to your machines vertical and horizontal cutters is transferred from electric motors via multi-ribbed rubber belts. These belts will stretch and wear from a combination of time and use, and may periodically require replacement.

Replacing stationary vertical cutter belt

1. Remove the collection hose and cover plate on the front of the MP260.

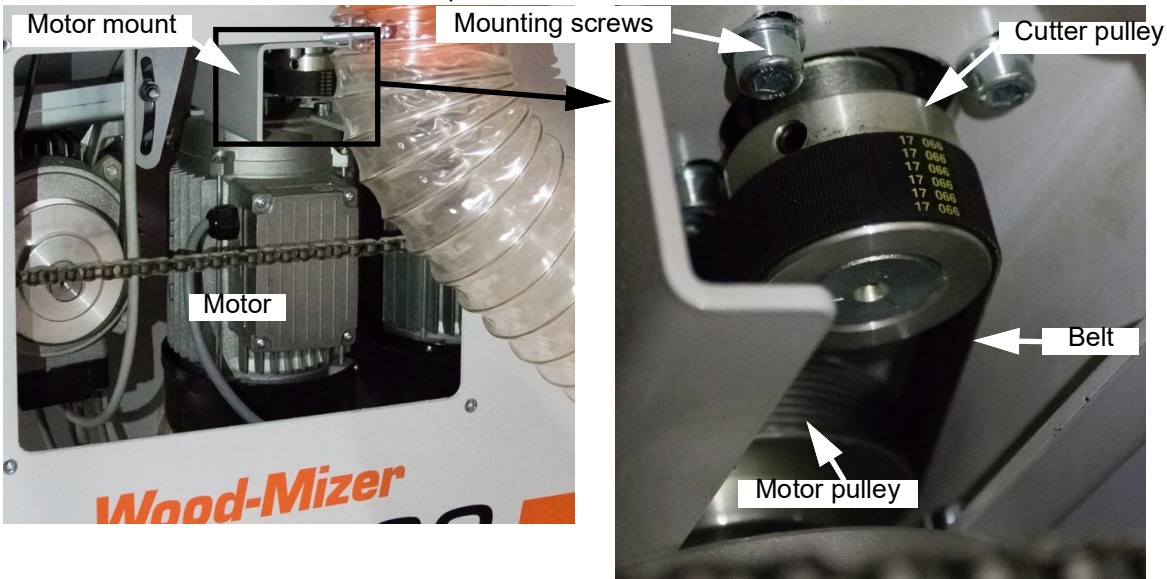
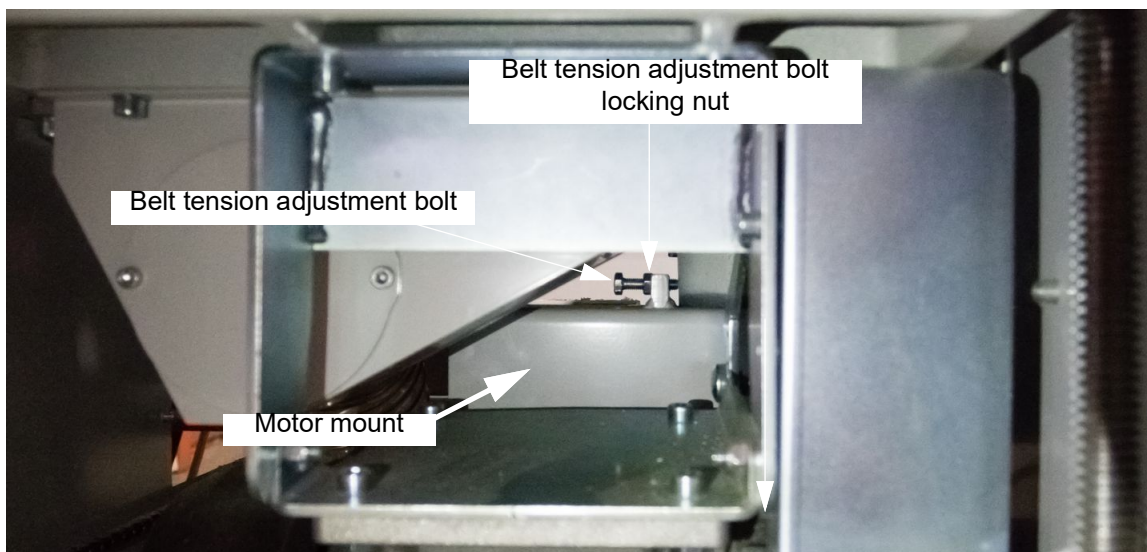

FIG. 5-11

2. Loosen (**do not remove**) 4 cap head mounting screws holding the pulley of the stationary vertical cutter. These screws pass through slots in the motor mount and fasten into the cast iron table.
3. Use a 6 mm hex key to loosen mounting screws one turn
4. Use a 13mm open-end wrench to loosen the locking nut that secures the tension adjusting bolt in place.
5. Loosen (**do not remove**) the belt tension adjustment bolt to remove the tension from the drive belt.



Viewed from infeed side

FIG. 5-12

6. Back out the tension adjusting bolt until **the front of the bolt is flush with the front of the belt tension bolt bracket**, but do not remove the bolt from the bracket.
7. From the front of the machine, pull the motor mount assembly towards you.

NOTE: The motor mount assembly's movement towards you is limited to approximately ½ inch (13 mm) before the tension adjustment bolt bracket makes contact with the cast iron table.

NOTE: The belt must be finessed over the top of the drive (motor) pulley and under the bottom of the cutter pulley to come straight out. The clearances are tight but it will come out.

8. Replace the belt in the reverse order of how you removed it.
9. Ensure the belt is aligned on both pulleys.
10. Push the motor mount back until there is sufficient tension on the belt for operation.
11. Set the belt tension adjustment bolt to hold the tension.
12. Set the belt tension adjustment bolt locking nut to secure the adjustment bolt.
13. Retighten the 4 mounting screws holding the pulley of the stationary vertical cutter.
14. Replace the cover plate and collection hose.

Replacing movable vertical cutter belt

This process is very similar to removing and replacing the stationary vertical cutter belt, but with a few minor differences related to the exterior parts of the machine you need to remove to gain access to the belt.

1. Remove the movable vertical cutter chip extractor hose mount.
2. Remove rear cover of the movable vertical cutter. The chip extractor hose mount and hose will come off with the cover.
3. Remove the outfeed side panel.

The remaining steps in this process are the same as those explained in the section [“Replacing stationary vertical cutter belt” on page 7.](#)

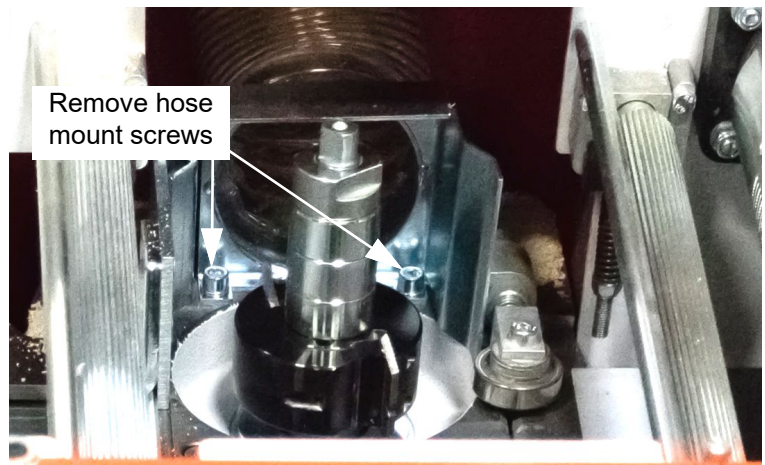

FIG. 5-13

5 Maintenance

Sharpening Knives

4. Use a 6 mm hex key to loosen mounting screws one turn.
5. Loosen (**do not remove**) 4 cap head mounting screws holding the pulley of the stationary vertical cutter. These screws pass through slots in the motor mount and fasten into the cast iron table.
6. Loosen (**do not remove**) the belt tension adjustment bolt to remove the tension from the drive belt. See FIG. 5-15 .

NOTE: The belt tension adjustment bolt on the movable vertical cutter is accessible from the top of the machine.

7. Use a 13mm open-end wrench to loosen the locking nut that secures the tension adjusting bolt in place.
8. Back out the tension adjusting bolt until **the front of the bolt is flush with the front of the belt tension bolt bracket**, but do not remove the bolt from the bracket.
9. From the front of the machine, pull the motor mount assembly towards you.

NOTE: The motor mount assembly's movement towards you is limited to approximately ½ inch (13 mm) before the tension adjustment bolt bracket makes contact with the cast iron table.

NOTE: The belt must be finessed over the top of the drive (motor) pulley and under the bottom of the cutter pulley to come straight out. The clearances are tight but it will come out.

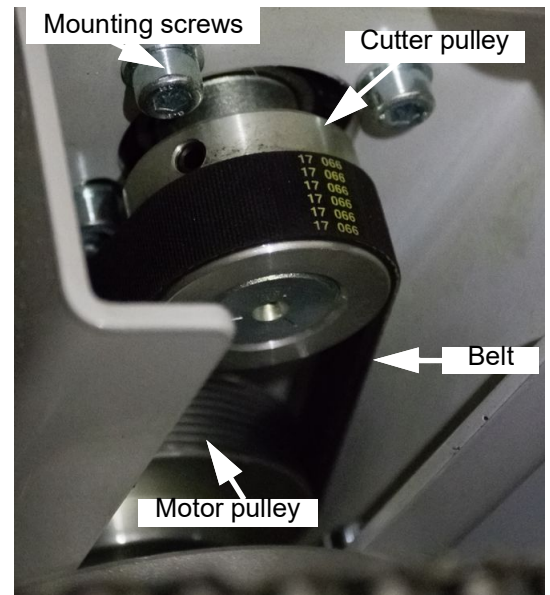
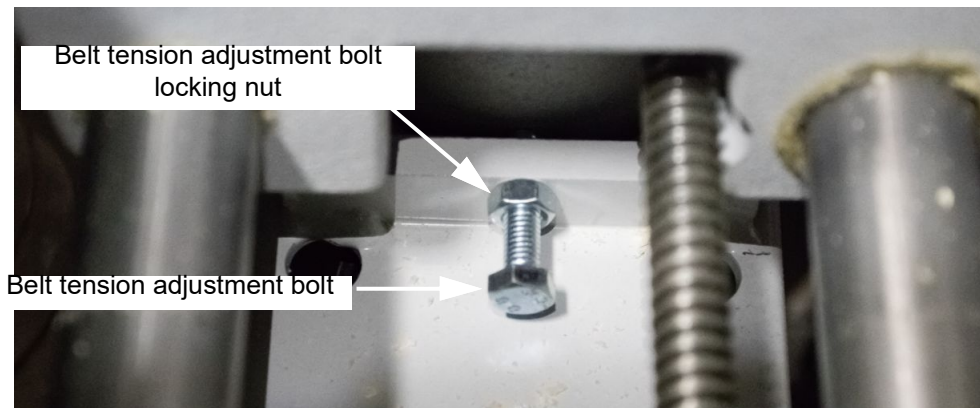

FIG. 5-14



Viewed from top of unit

FIG. 5-15

10. Replace the belt in the reverse order of how you removed it.
11. Ensure the belt is aligned on both pulleys.
12. Push the motor mount back until there is sufficient tension on the belt for operation.
13. Set the belt tension adjustment bolt to hold the tension.
14. Set the belt tension adjustment bolt locking nut to secure the adjustment bolt.
15. Retighten the 4 mounting screws holding the pulley of the vertical cutter.
16. Replace the cover plate and collection hose mount.

5.11 Sharpening Knives

The condition of your machine's knives will affect the quality and precision of the cut. Pay close attention to the quality of the cut to get an idea about the condition of the machine's knives. Dull knives will tear, not cut the wood fibers, producing a fuzzy appearance on the wood. A raised ridge (or ridges) running along the length of a wood plank can occur when a nicked knife impacts the wood.

On planer knives and moulding knives, it is possible to bring the knives back to a sharp condition by **sharpening the face of the knife**. Running a diamond stone against the face will bring knives back to a sharp condition. This can be done about 3 times before the knives will need to be sharpened by a sharpening machine.

If a raised ridge occurs the entire length of the plank that you are processing, then the knife/knives have been nicked. Sharpened the knife/knives to remove the nick.

Knives that are not sufficiently sharp will heat up when cutting. If you see blackened edges on moulding knives, this is an indication that the knives are not sharp. Continuing to use these knives will cause excessive wear on the machine, and will further degrade the knives themselves and the workpiece results. Remove and sharpen the knives.

The feed rate of the material being fed through the machine can have an affect on knife life. Ideally, with each revolution of the cutting head, the planer knife should be removing new material. The new material will absorb a portion of the heat created by the knife cutting the wood, and will cool the knife as it is cut away. However, if the knife is not cutting new material each time the cutting head makes a revolution, the friction created will cause both the knife and the wood to heat up. Excessive heat will dull your machines knives and shorten their life, and mar your workpiece.

Utilizing a test board, set the feeding speed of the machine so that chatter marks become visible, and then reduce the speed until a smooth finish is seen. This method will ensure that the knives are cutting new wood on each revolution. The optimal feeding speed will vary between the type of wood being processed, and the type of moulding knives being used.

SECTION 6 TROUBLESHOOTING



DANGER! Disconnect power before clearing debris or **any other maintenance activity**. Failure to follow this will result in serious injury or death.

Follow the OSHA lockout procedures reprinted in the Safety section.

Keep hands away from the knives.

Do not operate the planer moulder without all covers and guards in place.

OPERATION PROBLEMS

Problem	Possible Cause	Solution
In-and out-feed marks (snipes)	<ol style="list-style-type: none"> 1. Incorrectly adjusted in- and out-feed tables. 2. The workpieces are not butted when being fed into the machine. 3. The feed pressure of the feed rollers is incorrectly adjusted. 4. The workpiece is bent or warped. 5. There is play in the suspension of the machine table. 	<ol style="list-style-type: none"> 1. Adjust the in- and out-feed tables so that they are set to the same height as the machine table. The tables must also be in line with the machine table or somewhat higher at the outer ends. 2. Butt the workpieces end to end when feeding them into the machine. This will eliminate the variations of the feed pressure that can occur the moment the feed rollers grab the workpiece. 3. Make sure that the feed pressure is sufficient and that the rollers are balancing horizontally over the workpiece. 4. Slightly lift the back end of the workpiece when it is being fed into the machine. This will make it possible for the feed rollers to press the workpiece flat against the machine table. 5. By using little force, check if the machine table can be wobbled in any direction. If this is the case, see Leveling the machine.
The entire surface is fuzzy.	<ol style="list-style-type: none"> 1. The workpiece has high moisture content. 2. The knives have lost their edge. 	<ol style="list-style-type: none"> 1. Dry the lumber before machining it. 2. Grind the knives. Sharp knives are important when machining soft or moist wood.
Fuzzy surface around knots, where the direction of the fibers can vary	<ol style="list-style-type: none"> 1. The workpiece has high moisture content. 2. The knives have lost their edge. 3. The workpiece is of a too soft sort of wood. 	<ol style="list-style-type: none"> 1. Dry the lumber before machining it. 2. Grind the knives. Sharp knives are important when machining soft or moist wood. 3. Choose another material, or sand the workpiece after it has been machined.
The thickness of the board does not correspond to the setting of the scale.	<ol style="list-style-type: none"> 1. The takeoff of the knives in the upper cutter are set incorrectly. 2. The height scale is set incorrectly. 	<ol style="list-style-type: none"> 1. Set the takeoff of the planing knives to 1 mm, using the setting block supplied, or a straightedge. 2. Refer to Calibrating thickness indicator.
The edges of the molding knives are visible in the machined moulding profile.	<ol style="list-style-type: none"> 1. The planing knives do not cut away enough wood. 2. The moulding knives are ground incorrectly 	<ol style="list-style-type: none"> 1. Set the takeoff of the planing knives to 1 mm, using the setting block supplied, or a straightedge. 2. Regrind the moulding knives so that their edges do not protrude over the level of the planing knives, or use adjustable, short knife clamping gibs to adjust the moulding knives correctly.
The width of the machined board differs.	<ol style="list-style-type: none"> 1. The workpiece moves away from the side fences. 2. The locking handle of the movable cutter has not been tightened. 3. The spring mechanism of the pressure rollers is stiff. 4. The workpiece is too small for the measurement the machine is set to. 5. The stationary side cutter cuts away too much wood. 	<ol style="list-style-type: none"> 1. The right-side fences are set incorrectly. Adjust them according to the instructions. 2. Pull the handle tight before planing/ moulding. 3. Clean and lubricate the spring mechanisms of the three pressure rollers. 4. Set the machine to the correct width. 5. Decrease the feed rate or the takeoff of the stationary cutter.

Problem	Possible Cause	Solution
The surface of the workpiece's right side is below par.	1. The locking handle of the movable side cutter has not been tightened.	Pull the handle tight before planing/ moulding.
Splintering of the workpiece from the movable side cutter.	1. Too much takeoff.	1. Plane the workpiece to size before the final machining.

6.1 Mechanical or electrical problems

Problem	Possible Cause	Solution
None of the motors can be started.	<ol style="list-style-type: none"> 1. The cover is not entirely closed. 2. The emergency stop button is pressed down. 3. No power is supplied to the machine. 4. One of the motors is overheated. 5. Fault in the electrical system of the machine. 6. A fuse has blown in the electric box of the machine. 7. Wood debris has accumulated in the cover's safety switch. 8. The protective plate on the infeed opening is depressed. 	<ol style="list-style-type: none"> 1. Firmly tighten the locking knob on the cover. You can hear a soft click when the safety switch is activated. 2. Reset the emergency stop button by pulling it outwards. 3. Check the residual circuit breaker and the fuses in the building. Also check the connecting cable. 4. Wait until the overheating protection of the motor automatically resets (see the point, "The motor gets overheated."). 5. The electrical system may only be opened by a qualified electrician: First of all, check the safety hold circuit. This circuit includes, among other things, the emergency stop button and the overheating protections in the connection block on each motor. 6. The machine has one or two automatic fuses. Reset the fuse that has blown. If the problem recurs, let a qualified electrician find the cause of the problem and, if necessary, replace the fuse. 7. The electrical system may only be opened by a qualified electrician: Open and clean the safety switch from wood debris. 8. Clear the area around the infeed and clean around the limit switch.
The workpiece is fed poorly or not at all through the machine.	<ol style="list-style-type: none"> 1. The shear pin in the out-feed roller is broken. 2. Wood debris and resin have accumulated in the grooves of the feed rollers and on the out-feed roller. 3. The pressure of the feed rollers is too low. 4. The vertical movement of the feed rollers is obstructed by wood debris that has got stuck in the vertically movable bearing housings of the feed rollers or in the springs under these. 5. Wood debris has accumulated around the upper cutter. 6. The machine table is covered with resin or rust. 7. The sliding strips under the feed rollers are defective. 8. One (or several) of the sprockets in the chain transmission of the feeder has come loose from the shaft. 	<ol style="list-style-type: none"> 1. Remove the feed motor and replace the broken shear pin. 2. Clean the feed rollers. 3. Increase the feed pressure and make sure the feed rollers are balancing horizontally over the workpiece. 4. Clean the bearing housings of the feed rollers, especially check the movable part of the bearing housing. Remove wood debris that has got stuck in the springs of the feed rollers. 5. Remove the wood debris and increase the air flow in the chip extractor of the upper cutter. 6. Clean and lubricate the table. 7. Replace the sliding strips and fasten the new ones with double coated tape, if necessary in several layers, so that the sliding strips are about 0.5 mm above the surface of the machine table. 8. Check the locking screws of the sprockets and tighten them against the flat part of the shaft.
The upper cutter rotates a long time after the machine has been shut off (the deceleration should be max. 10 seconds).	<ol style="list-style-type: none"> 1. The fuse on the brake card has blown. 2. The brake card is defective. 	<ol style="list-style-type: none"> 1. Replace the glass fuse on the card. 2. Replace the defective brake card. On the new brake card there is a potentiometer that has to be adjusted (about 1/4 turn from 0).

6 Troubleshooting

Mechanical or electrical problems

Problem	Possible Cause	Solution
One of the motors will not start.	<ol style="list-style-type: none"> 1. Defective contact. 2. Defective motor. 3. A cable to the contact or to the motor is loose. 	<ol style="list-style-type: none"> 1. The electrical system may only be opened by a qualified electrician: Replace the defective contact. 2. The electrical system may only be opened by a qualified electrician: Replace the defective motor. 3. The electrical system may only be opened by a qualified electrician: Ensure that all cables are correctly connected.
The workpiece is fed jerkily through the machine.	<ol style="list-style-type: none"> 1. The machine table is covered with resin or rust. 2. One of the feed rollers has been bent. 	<ol style="list-style-type: none"> 1. 6. Clean and lubricate the table. 2. Replace the bent feed roller.
The machine runs for a while but then stops.	<ol style="list-style-type: none"> 1. One of the motors, in most cases the motor of the upper cutter, gets overheated. 	<ol style="list-style-type: none"> 1. See the next point, "The motor gets overheated."
The motor gets overheated.	<ol style="list-style-type: none"> 1. Wood debris has accumulated in the chassis of the machine or around the cooling fans of the motors. 2. Dull knives. 3. Too low voltage in the power supply. 4. Loose or bad connection in the power supply to the machine or in the electrical system of the machine. 5. The upper cutter removes too much wood. 6. The feed rate is too high. 	<ol style="list-style-type: none"> 1. Make sure that wood debris has not accumulated in the machine, and that the cooling fans of the motors have free flow. If the motors are kept clean they will be cooled more efficiently. 2. Grind or replace the knives. 3. The electrical system may only be opened by a qualified electrician: Check that you have the correct voltage on all phases. 4. The electrical system may only be opened by a qualified electrician: First of all, check that the connecting cable has the correct current and voltage during operation. Also check that all wires are correctly connected in the electrical system and motors of the machine. 5. If the workpiece is too wide, of a hard sort of wood or of varying oversizes: plane it into size before the final machining. 6. Decrease the feed rate.
Play in the adjusting crank of the movable side cutter.	<ol style="list-style-type: none"> 1. The bronze bearing in the bearing housing of the crank is defective. The crank may have been turned when the locking handle of the carriage is tightened. 	<ol style="list-style-type: none"> 1. Replace the bronze bearing and remember to open the locking handle under the table before adjusting the side cutter.
Vibration or rumble in the side cutter.	<ol style="list-style-type: none"> 1. The moulding knives are incorrectly mounted. 2. The moulding knives are incorrectly ground. 3. Defective bearing. 4. The spindle shaft has been bent due to overloading. 5. The drive belt is defective or improperly tensioned. 	<ol style="list-style-type: none"> 1. Demount the cutter head, and clean and mount the knives and the chip breakers correctly. Identical knives should be mounted on opposite sides of the cutter. 2. Grind the knives in pairs so that they are identical on the opposite sides of the cutter. 3. Replace the bearing. 4. Replace the spindle shaft. 5. Clean the belt pulleys and replace or properly tension the belt.
Rumbling or vibration in the upper or the lower cutter.	<ol style="list-style-type: none"> 1. The moulding knives are incorrectly mounted. 2. The moulding knives or the planing knives are incorrectly ground. 3. The bearing is defective. This can be due to wood debris accumulated on the back of the bearing housing, which leads to overheating. 4. The drive belt is defective or improperly tensioned. 	<ol style="list-style-type: none"> 1. Clean the cutter and mount the knives and the chip breakers correctly. Identical knives should be mounted on opposite sides of the cutter without any, or with only slightly horizontal deviation. 2. Grind the knives in pairs so that they are identical on opposite sides of the cutter. 3. Clean the bearing housing and replace the bearing. 4. Clean the belt pulleys and replace or properly tension the belt.
It is difficult to adjust the height of the machine table.	<ol style="list-style-type: none"> 1. The threaded bars on which the table is suspended, are dirty and not lubricated. 2. Faulty chain transmission. 3. The machine has been subject to impact which has spoiled the setting of the table. 	<ol style="list-style-type: none"> 1. Clean and lubricate the threaded bars with oil. 2. Make sure that the chain runs correctly on the sprockets. Clean and lubricate the chain. 3. Adjust the table. (See Leveling the machine of Setup)